

کوشا فرین دارمان

KOUSHAFARIN DARMAN

نماینده انحصاری ابزارهای **FALCON** و **KOUSHA** در ایران



DENTAL CATALOGUE

2024

DENTAL CATALOGUE

Contents

Diagnostic Page 02-03

Periodontal Page 04-05

Restorative Page 06-15

Endodontic Page 16-17

Anesthesia Page 18

Extraction Page 19-25

Implantology Page 26-34

Dental Surgery Page 35-39

Surgery Page 40-44

Laboratory Page 45-46

Ortodontic Page 47-49

Sterilization Page 50-53

Mouth Mirrors

Pack of 12 pieces

سر آینه ۱۲ عددی



- Made of 18-8 Stainless steel
- Sterilizable up to 200° C
- Best reflection and image quality

Fig	Plan	Magnifying
Fig. 4	F 509.040 K 1335	F 506.040 K 1333
Fig. 5	F 509.050 K 1336	



Fig. 4
Ø 22 mm
سر آینه شماره ۴



Fig. 5
Ø 24 mm
سر آینه شماره ۵

Mirror Handles

دسته آینه
هشت گوش



F 540.010
K 1346

دسته آینه
هالو



F 545.010
K 1348

دسته آینه
ارگونومیک



F 530.010

دسته آینه
گرد آبی



F 526.010

دسته آینه
گرد سبز



F 526.020

دسته آینه
گرد زرد



F 526.030

دسته آینه
گرد قرمز



F 526.040

دسته آینه
گرد نارنجی



F 526.050

Tweezers



F 901.150 پنس ارگونومیک



F 945.010 | K 1352 پنس دو خم



F 910.050 پنس یک خم



K 1351 پنس نوک تیز



F 930.050 | K 1360 پنس قفل دار



F 586.020 پنس اندودنتیک قفل دار



F 980.130 | K 1359 پنس گوتا (Curved)



F 981.130 پنس گوتا (Angled)

Examination Kit

F 990.050 ست معاینه
K 1001



Explorers



F 105.050 سوند دو سر هالو

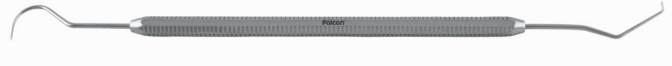

F 197.050 | K 1305 سوند دو سر

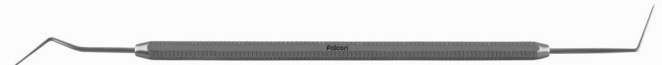

F 584.167 سوند دو سر



F 584.177 سوند دو سر



F 584.237 | K 1306 سوند دو سر



K 1307 سوند دو سر



F 397.230 | K 1301 سوند یکسر داسی

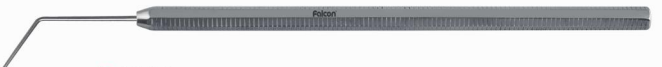

K 1302 سوند یکسر

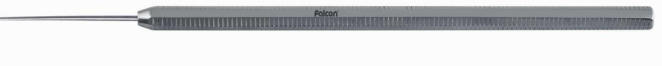

K 1303 سوند یکسر



F 397.080 | K 1304 سوند یکسر اندو

Contents

- 1 x F 540.010 | K 1346 دسته آینه
- 1 x F 509.040 | K 1335 سر آینه
- 1 x F 197.050 | K 1305 سوند
- 1 x F 945.010 | K 1352 پنس

Curettes Classic - 8

قلم های جرمگیری دسته ساده

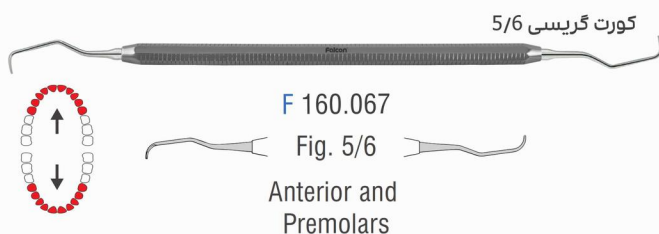
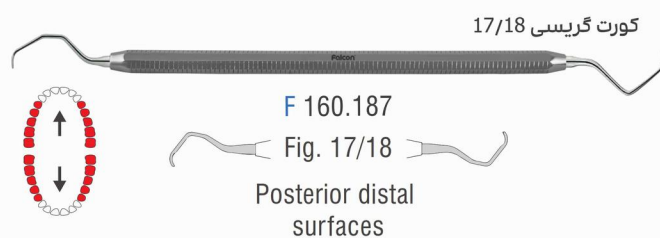
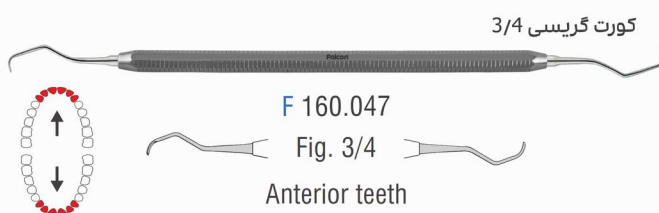
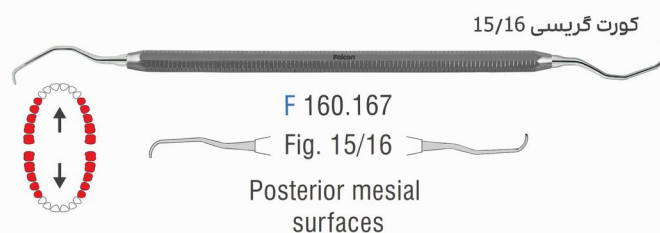
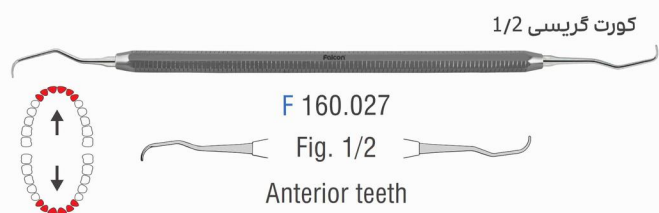

Sickle Scaler

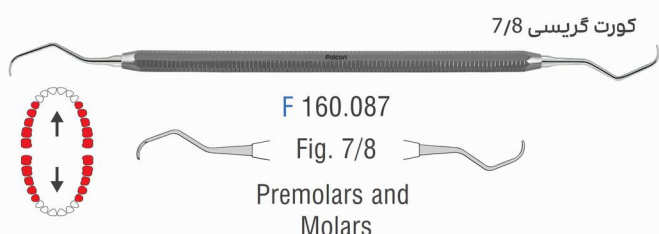
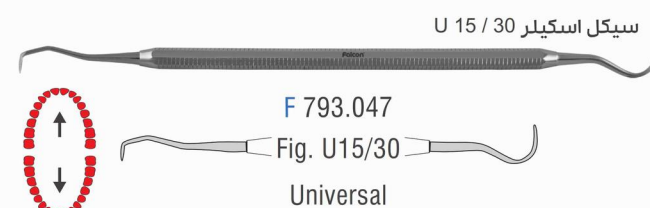

Columbia

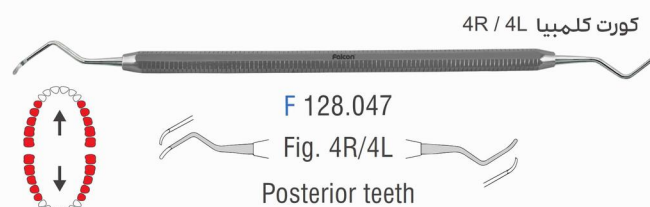
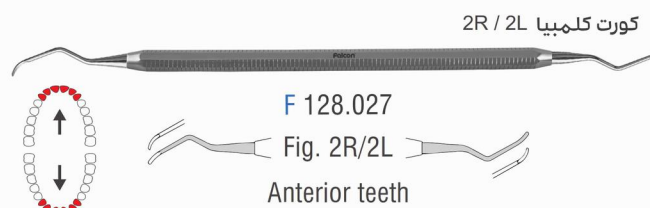
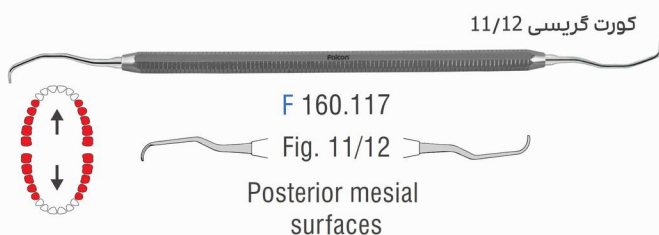
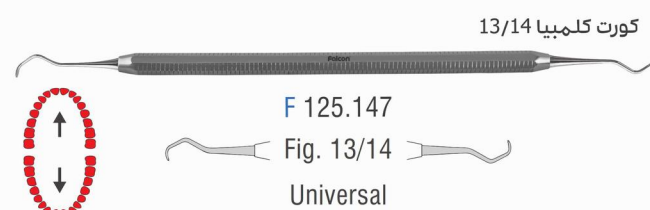
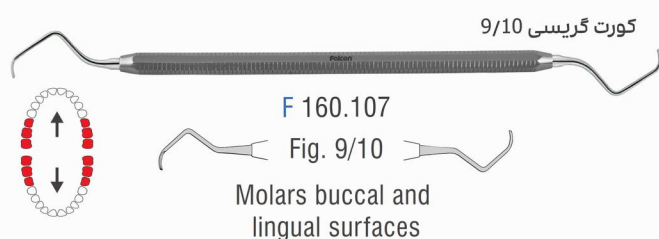

Curettes Classic Lite

قلم های جرمگیری دسته هالو

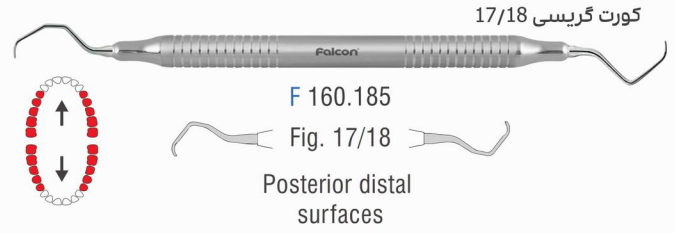
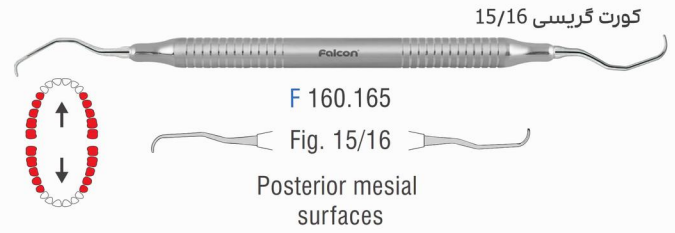
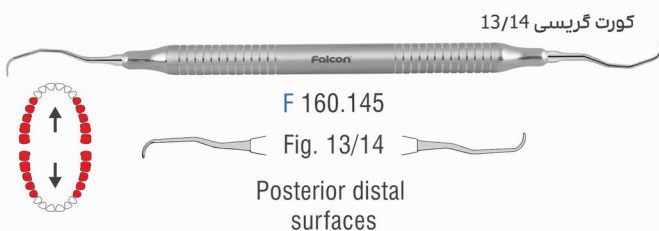
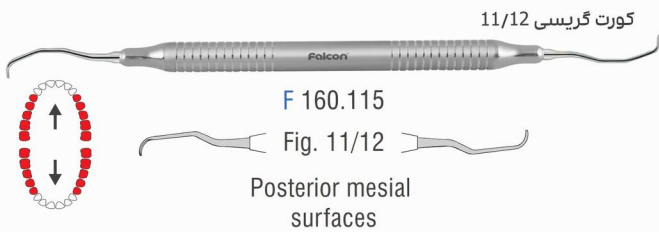
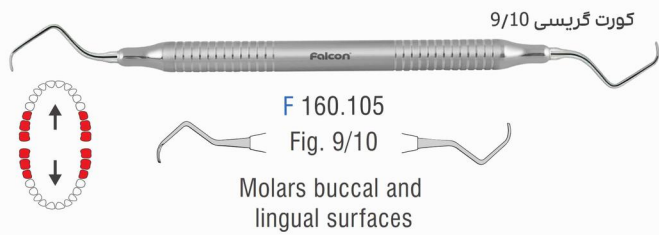
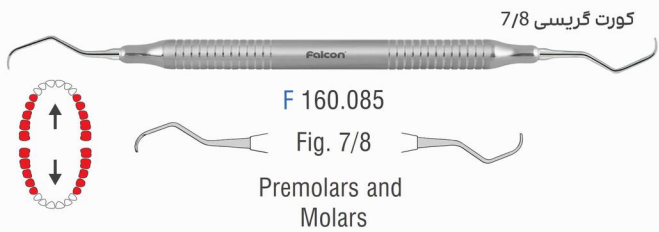
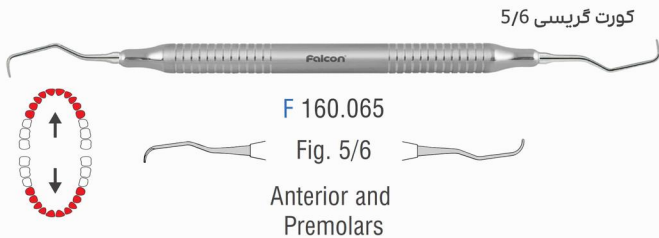
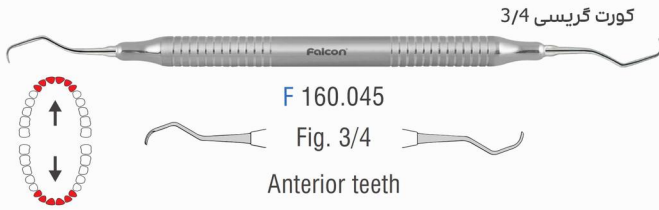
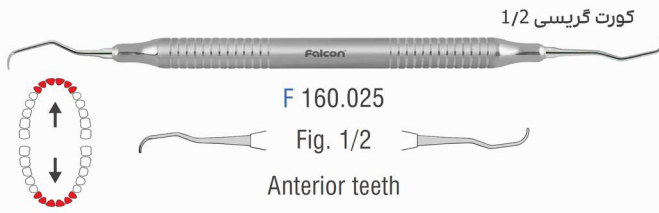

Sickle Scaler

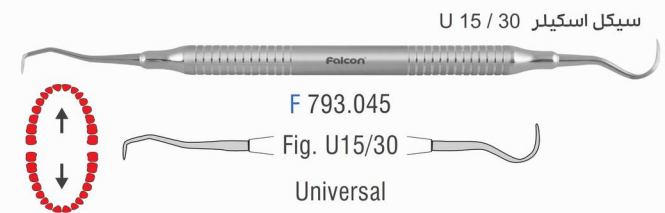

Williams Probes



Compo-fill Instruments

قلم های کامپوزیت دسته ساده



K 1883
Wescott 2.0 - 2.5 mm



K 1892
Condenser WORD (cutt) & spatual rigid



K 1884
Wescott 3.0 - 3.5 mm



K 1893
Hollen back & Condenser mini cutt



K 1885
Plastic Filling Rigid 3.0x11.5 3.0x9.5 mm



K 1894
Freedman cone shape & Condenser



K 1886
Condenser & Headmen spatual rigid



K 1895
Burnisher 1.3 - 1.6 mm



K 1887
Plastic Filling 2.0x10.0 2.0x8.5 mm



K 1896
burnisher 1.6 mm , 2.2 mm



K 1888
Plastic Filling 2.0x10.0 2.0x8.5 mm



K 1897
Smooth plugger 2.5mm 2.5 mm



K 1889
Plastic Filling 2.0x11.5 2.5x9.5mm



K 1898
Headman rigid & cement Spatual (curv)



K 1890
Freedman Condenser, 1.0 MM 1.3mm



K 1899
Universal rigid & Lekran 3.0 mm 4.0



K 1891
Condenser, 1.6 mm Mini Spatual/placer 3.0 mm



K 1900
Boghosiyian

Compo-fill Instruments قلم های کامپوزیت دسته هالو



K 1401
Burnisher 1.3 - 1.6 mm



K 1402
Plugger sharp (hollen-back)



K 1403
Plugger (hollen-back) 2.5



K 1404
Freedman condenser ,markly-S



K 1405
Freedman condenser , markly-L



K 1406
Westcott (s) 2.0 - 2.5 mm



K 1407
Westcott (L) 3.0 - 3.5 mm



K 1408
Plastic instruments & condenser sharp 1.6 -1.2mm-S



K 1409
Plastic instruments & condenser - L



K 1410
Heidemann spatula-S



K 1411
Heidemann spatula 2.0 mm-L



K 1412
Heidemann-1.5mm



K 1413
Plastic filling instrument elastic 2 mm



K 1414
Plastic filling instrument elastic 2.5 mm



K 1415
Placement instruments mini spatula/placer



K 1416
Plastic filling Rigid-L



K 1417
Plastic filling Rigid 2.0 mm



K 1418
Cement spatula 2.0 mm flexible



K 1419
Mini spatula /placer pluggar 3.1 mm 101 mm



K 1420
Bagoshian



K 1421
Heidemann rigid & cement Spatula



K 1422
Super plugger (heleomolar type)

Pluggers

کندانسورهای آمالگام مخروطی

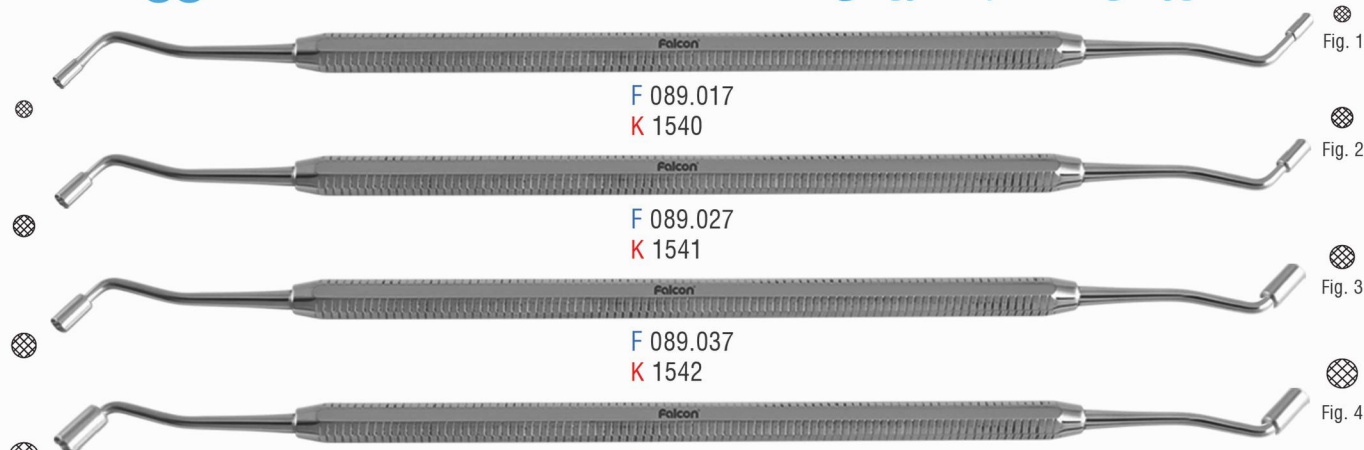

کندانسورهای کامپوزیت (بدون عاج)

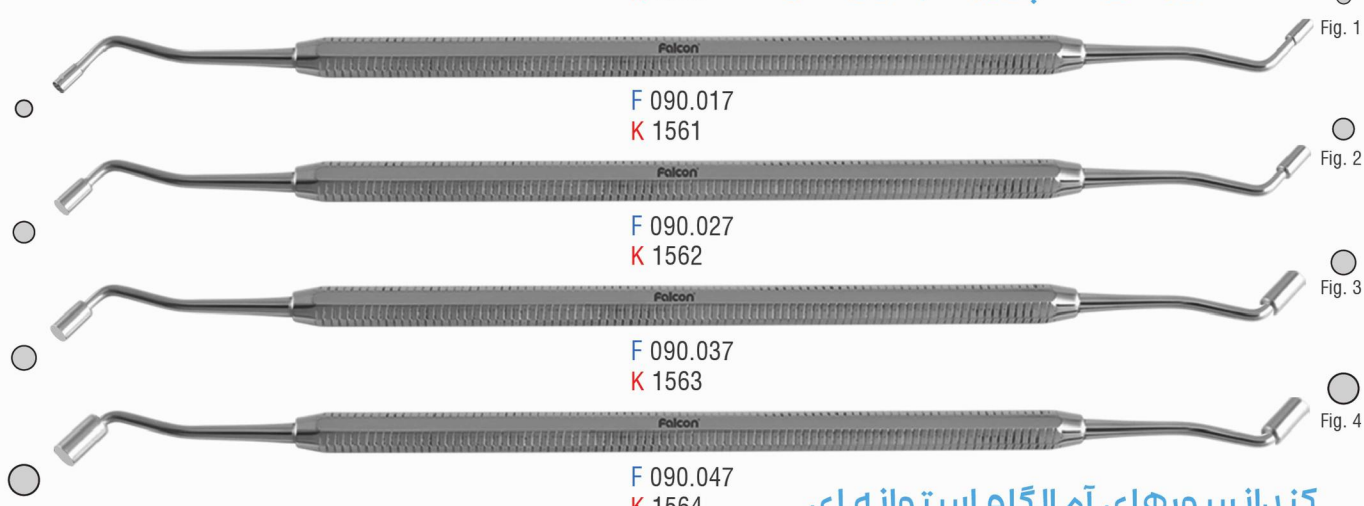

کندانسورهای آمالگام استوانه ای

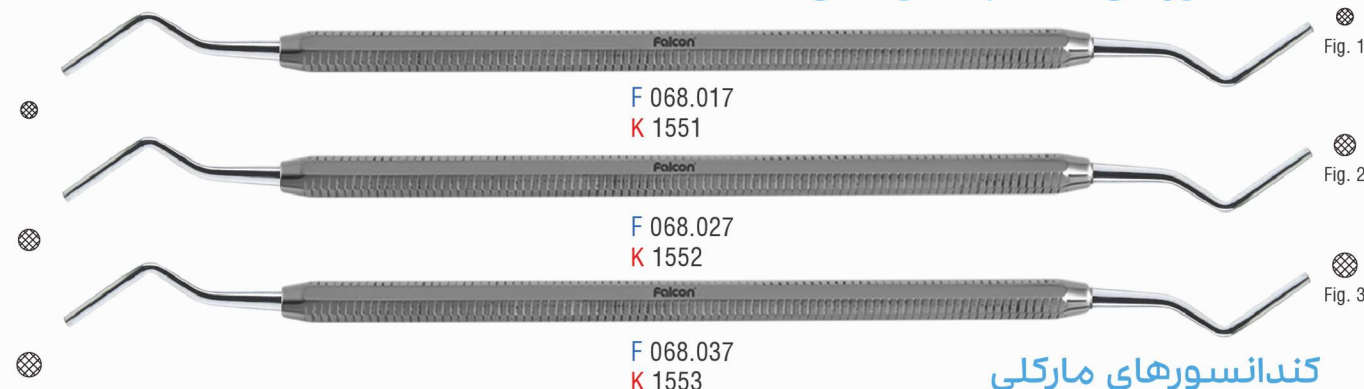

کندانسورهای مارکلی

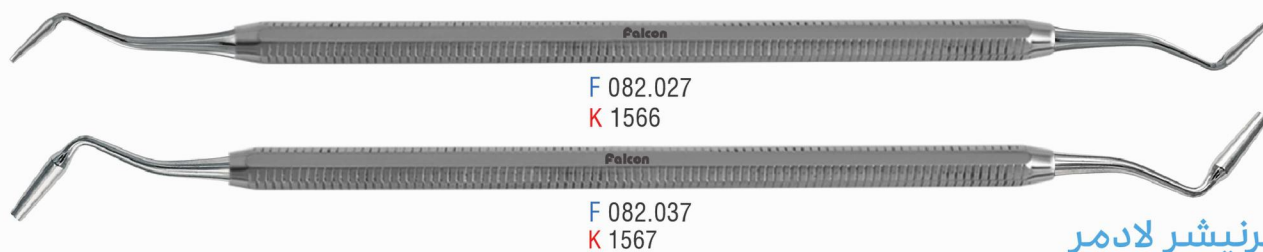

برنیشر لادمر



Plugger - Burnisher

برنیشر



F 130.017
K 1501



F 130.027
K 1502



F 130.037
K 1503



F 130.047
K 1504

کندانسور - برنیشر



K 1510



K 1511



K 1512



K 1513



K 1514



K 1515

تی برنیشر - برنیشر تخم مرغی



F 148.377
K 1531



F 148.067
K 1535



K 1525



K 1528

Wescott

برنیشر وسکوت



F 110.217



F 111.217

Filling Instruments

اسپاتول دهانی



F 463.007

K 1487

Fig. 1



F 463.017

K 1466

Fig. 2



F 463.027

K 1467

Fig. 3

Woodson Spatula

اسپاتول ودسون



F 518.017

Fig. 1



F 518.027

Fig. 2



F 518.037

Fig. 3

Spatula

اسپاتول محکمہ



F 960.017

K 1451

Fig. 1



F 960.027

K 1452

Fig. 2



F 960.037

K 1453

Fig. 3

Cord Packer

قلم نخ زیر لثه



F 005.037

K 3246

Dycal Placement

قلم دایکال



F 872.001 دوسر

K 1598



F 872.002 یک سر

K 1597

Excavators

اکسکویاتور

Fig. 1



F 623.017
K 1601

Fig. 2



F 623.027
K 1602

Fig. 3



F 623.037
K 1603

Fig. 4



F 623.047
K 1604

Carvers

کارور لوزی ریز



F 204.107 S
K 1579

کارور لوزی متوسط



F 225.037
K 1580

کارور لوزی ۹۰ درجه



F 204.108
K 1581

کارور هولن باخ



F 230.037
K 1583

کارور نیزه ای

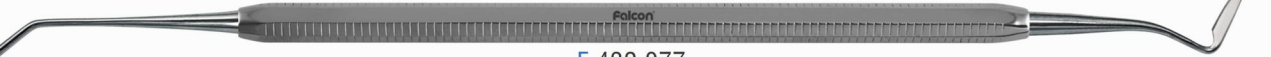

F 432.077
K 1584

کارور نیزه ای



F 270.017

کارور نیزه ای



F 270.027

Filling Instruments Set of 10 Pieces

ست ترمیم ۱۰ عددی

K 1500 F 999.007

Contents: 1 each of following :

K 1501 F 089.017

K 1502 F 089.027

K 1542 F 130.027

K 1543 F 130.037

K 1602 F 463.017

K 1580 F 960.027

K 1531 F 623.027

K 1467 F 225.037

K 1452 F 148.377

K 1597 F 872.002



Amalgam Carrier



F 028.010
K 1628
آمالگام کریر



F 022.101
آمالگام کریر
قابل تنظیم



F 026.010
آمالگام کریر
۴۵ درجه



F 026.020
آمالگام کریر
۶۰ درجه



F 026.030
آمالگام کریر
۹۰ درجه



F 028.000
آمالگام کریر پلاستیکی
قابل اتوکلاو
(همراه با سری اضافه)

MTA Carrier



F 024.020
K 3506
Ø 1.2x1.5 mm
ام تی ای کریر
سر صاف نازک



F 024.030
K 3507
Ø 1.2x1.5 mm
ام تی ای کریر
سر کج نازک

Amalgam Well

کوده آمالگام



F 098.010



K 1646



K 1647

Matrix Retainers



F 840.010
ماتریس بند
اطفال



F 840.030
K 1441
ماتریس بند
تافل مایر



F 830.087
ماتریس بند
مبا



F .832.010
ماتریس بند
نی استروم چپ



F 832.020
ماتریس بند
نی استروم راست



F 830.120
ماتریس بند
چنگی



F 024.040
K 3508
Ø 1.8x2.5 mm
ام تی ای کریر
سر صاف



F 024.050
K 3509
Ø 1.8x2.5 mm
ام تی ای کریر
سر کج

Manual Crown and Bridge Remover



آرچ کروان ساده
K 3201
Complete with 4 tips



آرچ کروان ساده
F 554.000
Complete with 3 tips



کروان اسپریدر
K 3220

Automatic Crown and Bridge Remover



آرچ کروان اتوماتیک
F 549.000
K 3210
3 Tips
1 Mounting kit
(wrench and key)



آرچ کروان اتوماتیک دکمه ایی
F 552.000
Contents
1 crown remover
3 tips
1 tightening key



آرچ کروان اتوماتیک دکمه ایی
K 3212
Contents
1 crown remover
4 tips

Rubber Dam Clamps



پرمولر پایین
بدون باله
F 906.020
K 1675
Fig. 27



پرمولر و قدامی
یونیورسال لبیال کوچک
F 906.090
K 1670
Fig. 9



پرمولر پایین
با طوق کوچک
F 906.100
K 1663
Fig. 00



پرمولر بالا و
پایین کوچک
F 906.130
K 1664
Fig. 2



پرمولر بالا و
پایین بزرگ
F 906.140
K 1665
Fig. 2A



پرمولر بالا و
پایین با باله
F 906.150
K 1678
Fig. 206



پرمولر
پایین کوچک
F 906.180
K 1679
Fig. 209



سانترال و کانین
لبیال
F 906.210
K 1680
Fig. 210



پرمولر و قدامی
یونیورسال لبیال بزرگ
F 906.211
K 1681
Fig. 211



قدامی
لبیال
F 906.212
K 1682
Fig. 212



مولر بالا
بدون باله
F 906.370
K 1674
Fig. 26



مولر بالا
و پایین کوچک
F 906.500
K 1666
Fig. 3



مولر
پایین
F 906.530
K 1667
Fig. 7



مولر
بالا کوچک
F 906.550
K 1668
Fig. 8



مولرهای نیمه
روییده و کوچک
F 906.560
K 1669
Fig. 8A



مولر بالا
چپ و راست
F 906.570
K 1671
Fig. 12A



مولر بالا
و پایین بزرگ
F 906.590
K 1672
Fig. 14



مولرهای نیمه
روییده و بزرگ
F 906.600
K 1673
Fig. 14A



مولر پایین
با باله
F 906.620
K 1676
Fig. 201



مولر
بالا بزرگ
F 906.660
K 1677
Fig. 205

Rubber dam clamps kit

ست کلمپ رابردم اعددی

F 909.100
K 1662
1 each of
Fig. 00, 2, 2A, 3, 7, 8A, 9, 14, 14A, 212



Rubber Dam Clamp Forceps



فورسپس کلمپ دوخم
F 926.170
K 1652



فورسپس کلمپ یک خم
F 932.170
K 1651



فورسپس کلمپ ایوری
F 928.170

Rubber Dam Template & Clamps Tray

الگوی رابردم
F 948.000
Autoclavable

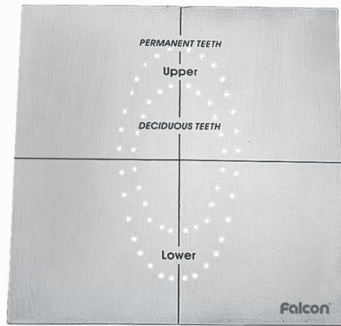

Rubber Dam Punches



فورسپس پانچ
F 940.160
K 1654

Matrix forceps



فورسپس سگشنال ماتریس
F 820.170
K 1438

Rubber Dam Frames

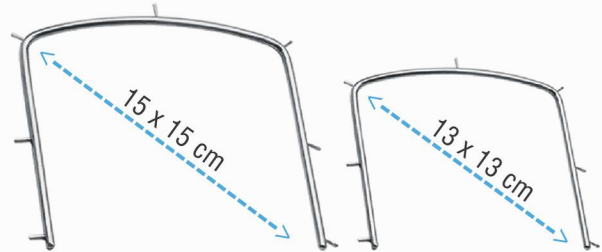

F 938.150

F 938.130



سینی کلمپ رابردم
F 904.010
Falcon

Rubber Dam Kit Of 14 PCS

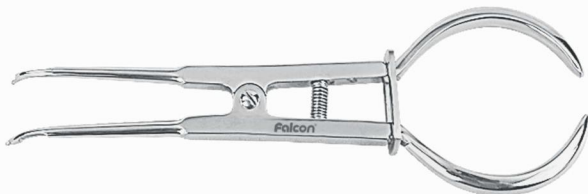

ست رابردم ۱۴ عددی
F 909.900
ست رابردم ۱۳ عددی
K 1700



Fig. 9



Fig. 2 A



Fig. 2



Fig. 14



Fig. 14 A



Fig. 212



Fig. 8A



Fig. 00



Fig. 7



Fig. 3



Forceps for Articulating Paper

پنس کاغذ ارتیکلاسیون



F 698.010
K 2751



F 700.010
K 2752



F 700.020

Splinter Forceps



هموستات اندودنتیک ۹۰ درجه
(مخصوص فایل های شکسته)
F 995.060

Latex Dental Dam



بسته 36 عددی
رنگ : سبز
طعم : نعنا



بسته 36 عددی
رنگ : آبی
طعم : بدون طعم

Endometer

اندومتر
بدون سوراخ
F 575.000
Endometer Petite
Laser etched



اندومتر
سوراخ دار
F 575.010
Endometer
Laser etched



اندومتر
بدون سوراخ
K 1960



Silver points and broken files removing forceps



هموستات اندودنتیک ۹۰ درجه
F 587.130

Pluggers
هندپلاگر

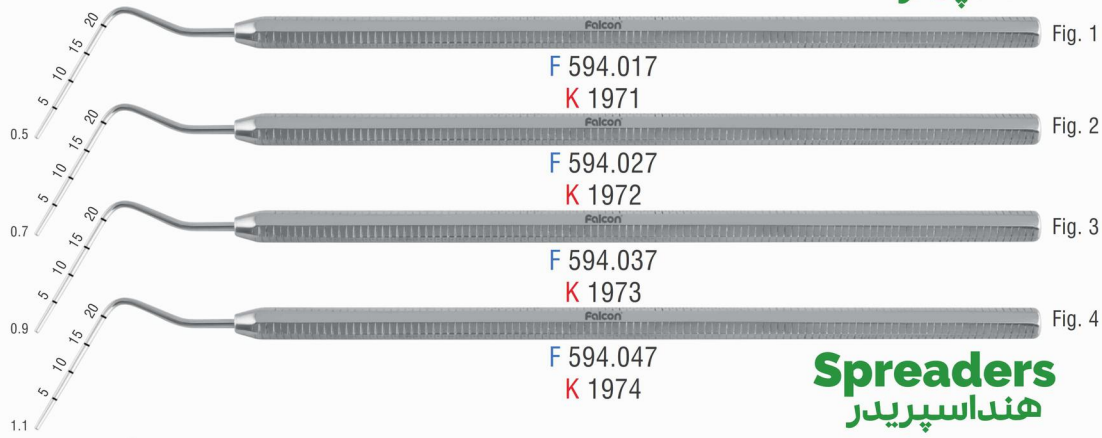

Spreaders
هند اسپریدر

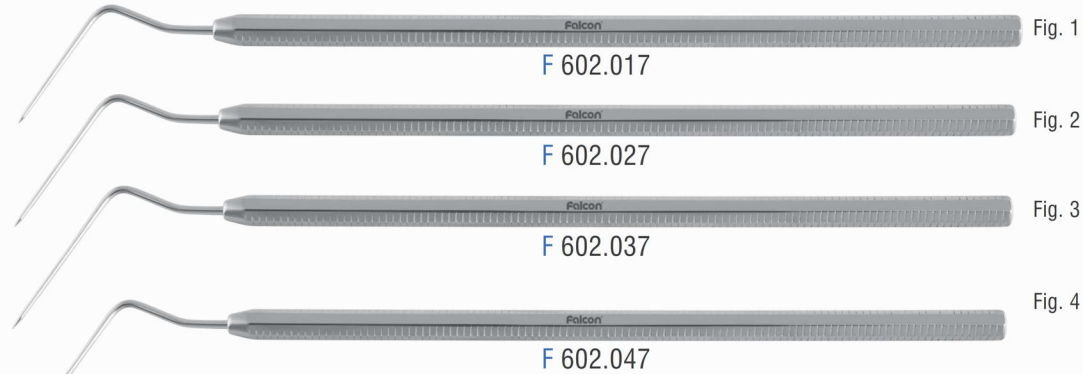

Heat Carriers
هیت کریر دسته هالو

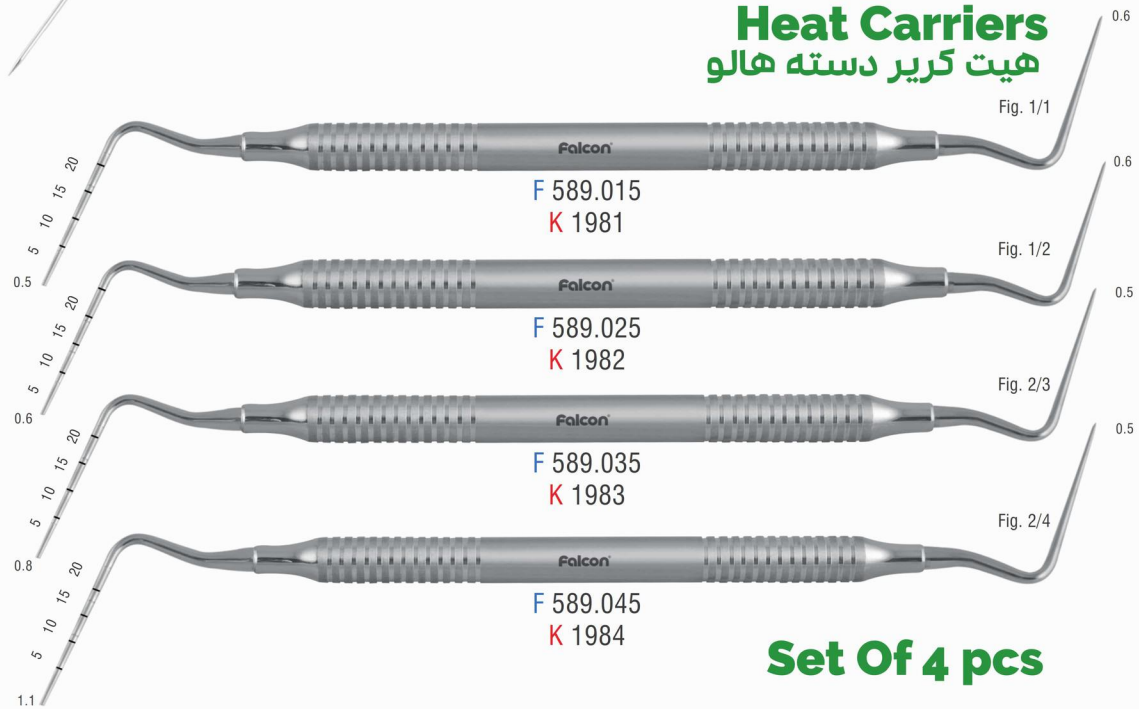

Set Of 4 pcs



ست هند اسپریدر
F 602.007



ست هندپلاگر
F 594.007
K 1980



ست هیت کریر
F 589.005
K 1990

Intraligamental Syringes

سرنگ تزریق



سرنگ تزریق
تدریجی

F 095.180

Swedish Type

Injects 0.06 ml with every click

F => FALCON
K => KOUSHA

Falcon
Your Instruments since 1975



سرنگ تزریق
تفنگی

F 060.180

Pistol-Ject

Injects 0.20 ml

with every click

Lever action for

high injection pressure

Manual Aspirating Floding Syringes

سرنگ تزریق کمرشکن



F 819.180

K 2251



Superme

K 2252

Manual Aspirating Fix Syringes

سرنگ تزریق ثابت



Type-C

F 562.180



K 2254

Needle Re-capper

نیدل ریکاپر اولتیما

Falcon Needle Re-Cappers are the ideal way to prevent needle stick injuries when recapping needles.

Place the upturned needle cap into Falcon Re-Capper and re-sheathing becomes a simple one hand procedure.



Ultima

F 990.000



Bein Elevators Round Tips

الواترهای سرصاف

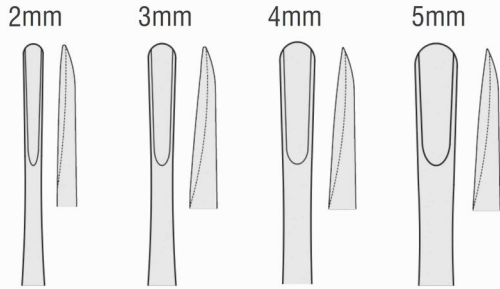

F 030.120 **F 030.130** **F 030.140** **F 030.150**
K 1201 **K 1203** **K 1205** **K 1207**

الواترهای سرکج (پاشنه ای)

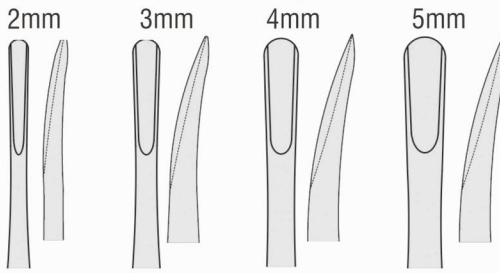

F 030.220 **F 030.230** **F 030.240** **F 030.250**
K 1208 **K 1210** **K 1212** **K 1214**



Luxation Elevators

الواترهای لوگزتینگ سرصاف

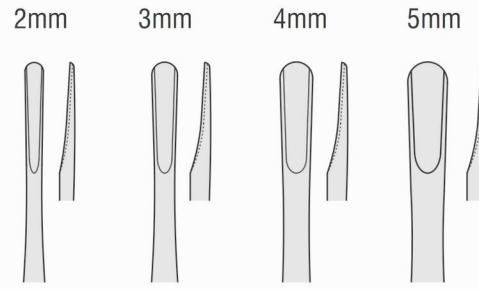

F 920.120 **F 920.130** **F 920.140** **F 920.150**
K 1221 **K 1223** **K 1225** **K 1227**

الواترهای لوگزتینگ سرکج (پاشنه ای)

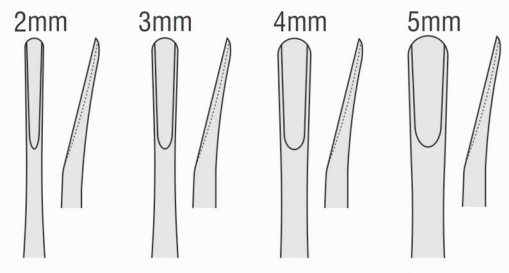

F 920.220 **F 920.230** **F 920.240** **F 920.250**
K 1228 **K 1230** **K 1232** **K 1234**

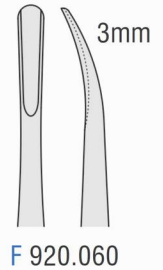
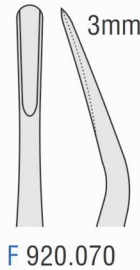

Elevators Set Of 7 pcs

ست الواتر ۷ عددی



F 999.008	K 1300
Contents	Contents
1 each of	1 each of
F 030.130	K 1202
F 030.140	K 1203
F 030.150	K 1205
F 070.250	K 1241
F 070.260	K 1242
F 086.022	K 1253
F 086.032	K 1254

Bein Elevators Pointed Tips

الواترهای نوک تیز سرصاف

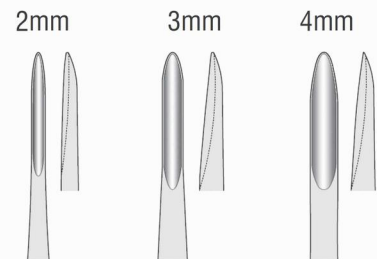

F 025.012 **F 025.062** **F 025.072**
K 1251 **K 1252**

الواترهای نوک تیز سرکج (پاشنه ای)

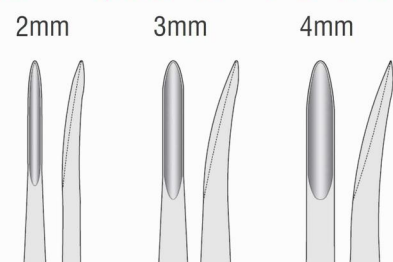

F 026.012 **F 026.022** **F 026.032**



Elevators

الواتر کرایر

12.5 mm

10 mm

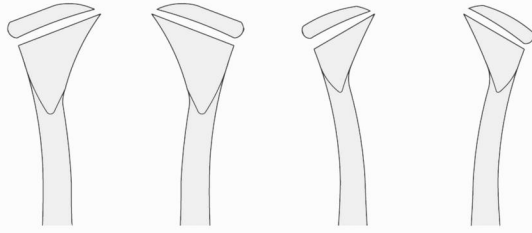

F 070.250 K 1247 Cryer Left
F 070.260 K 1248 Cryer Right
F 070.440 K 1245 Cryer Left
F 070.450 K 1246 Cryer Right

الواتر سلدین

13 mm

10 mm

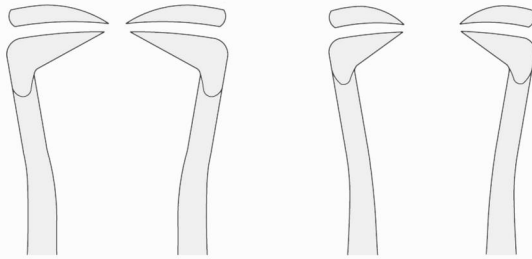

F 155.015 K 1241 Seldin Left
F 155.017 K 1242 Seldin Right
F 155.045 Fig. 4 L Seldin Left
F 155.047 Fig. 4 R Seldin Right

الواتر فلوهر

3.5 mm

3.5 mm

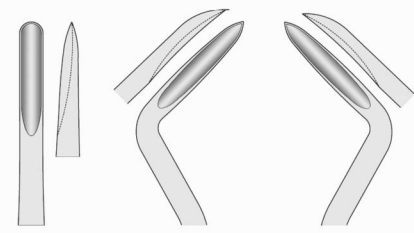

F 086.012 Fig. 1 Flohr
F 086.022 K 1253 Flohr Left
F 086.032 K 1254 Flohr Right

الواتر اپیکال

3 mm

3.5 mm

3.5 mm

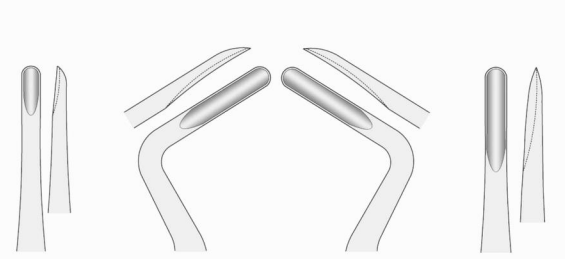

F 015.301 Fig. 301 Apical
F 015.302 Fig. 302 Apical Left
F 015.303 Fig. 303 Apical Right
F 015.304 Fig. 304 Apical

الواتر کوپلن

3 mm

3.5 mm

4 mm

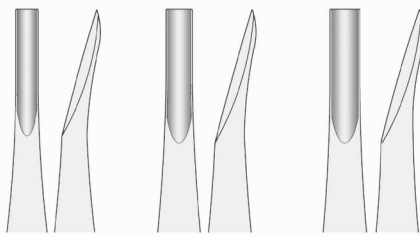

F 050.011 Fig. 1 Coupland
F 050.021 Fig. 2 Coupland
F 050.031 Fig. 3 Coupland

الواتر دندانه دار سر صاف

4.2 mm

3.5 mm

2.3 mm



F 115.010 K 1237 Lendo-Levian
F 115.020 K 1236 Lendo-Levian
F 115.030 K 1235 Lendo-Levian

الواتر فریدمن

3 mm

3 mm

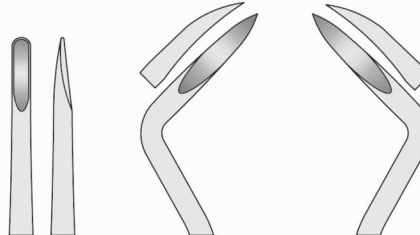

F 089.010 Fig. 1 Frideman
F 089.020 Fig. 2 Frideman Left
F 089.030 Fig. 3 Frideman Right

الواتر دندانه دار سر کج

4.2 mm

3.5 mm

2.3 mm

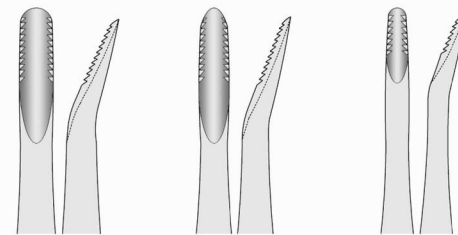

F 117.010 Fig. 1 Lendo-Levian
F 117.020 Fig. 2 Lendo-Levian
F 117.030 Fig. 3 Lendo-Levian

Heidebrink Elevators

الواتر مخصوص ریشه

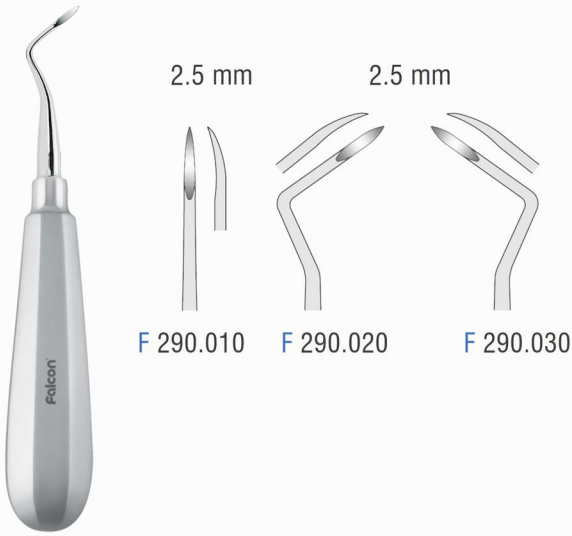

Coleman London Hospital

الواتر کلمن

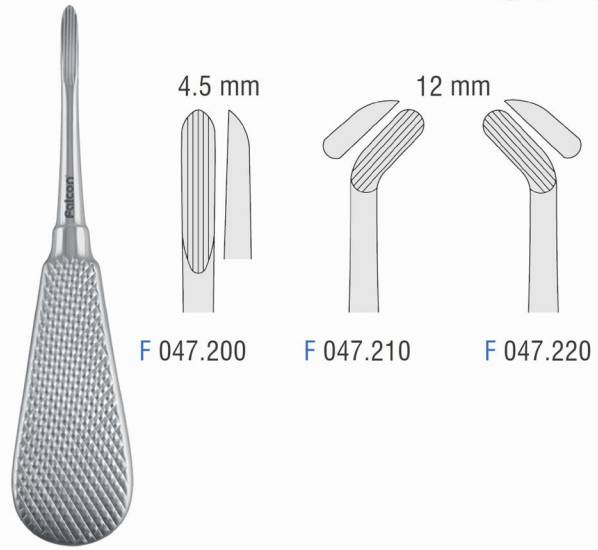

Heidebrink Elevators

الواتر مخصوص ریشه (دسته هالو)

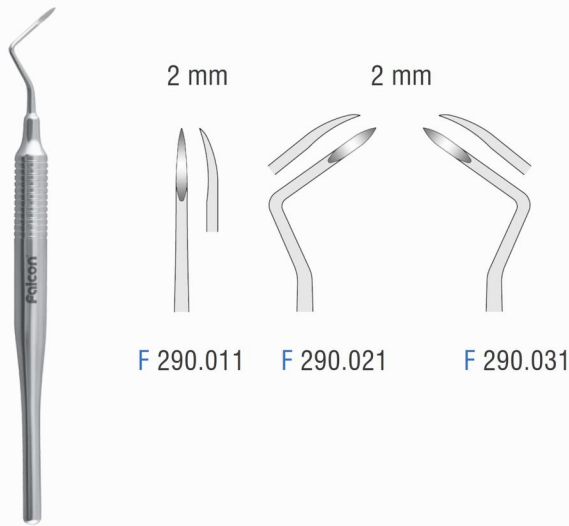

Warwick-James Elevators

الواتر اطفال



Elevators Anatomical Handles Set

ست الواتر آناتومیک (۷ عددی)



F 999.009
Contents
1 each of
F 030.530
F 030.540
F 030.550
F 070.251
F 070.261
F 086.021
F 086.031

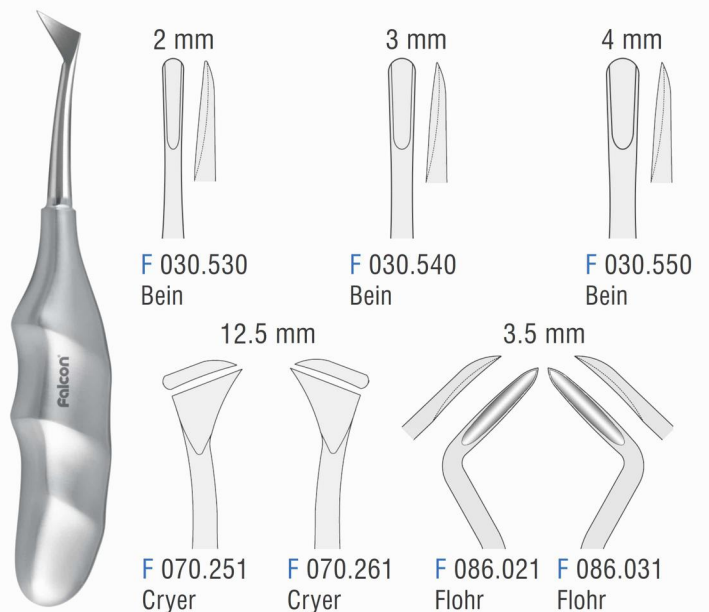

Cross Bar Elevators

الواتر صلیبی

10 mm

10 mm

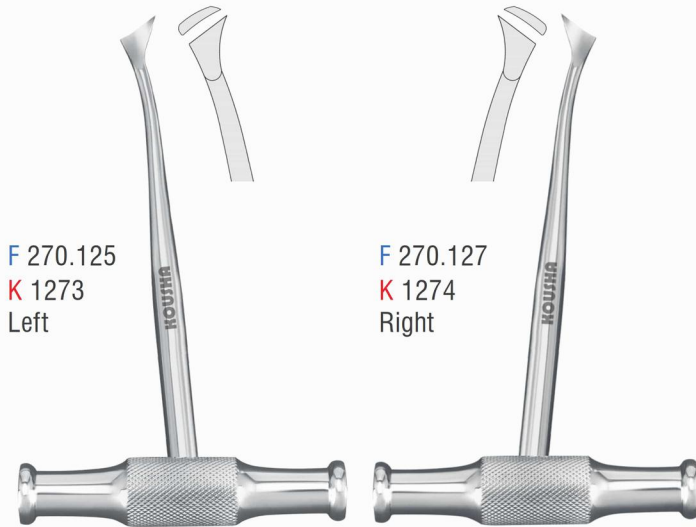
F 270.125
K 1273
LeftF 270.127
K 1274
Right**Bayonet Elevators**

الواتر نیزه ای

3 mm

5 mm

K 1256
Offset
Out TipK 1257
Offset
In Tip**PDL Periosteal Set**

ست پریوتوم های چکش خور

F 917.200 عددی ۷
K 3350F 917.270
K 3357F 917.260
K 3356F 917.250
K 3353F 917.240
K 3355F 917.230
K 3351F 917.220
K 3352F 917.210
K 3354**Extraction Physics Forceps**

فورسپس بزرگسال آتروماتیک

K 1134
آتروماتیک
قدامی بالاK 1133
آتروماتیک
یونیورسال پایینK 1132
آتروماتیک
بالا راستK 1131
آتروماتیک
بالا چپ

Extraction Forceps with Anatomical Handles

فورسپس های بزرگسال آناتومیک

ست فورسپس
آناتومیک ۱۱ عددی
F 820.002



Fig. 2

Fig. 7

Fig. 13

Fig. 17

Fig. 18



سانترال بالا
F 820.020



پرمولر بالا
F 820.070



پر مولر پایین
F 820.130



مولر بالا راست
F 820.170



مولر بالا چپ
F 820.180

Fig. 22

Fig. 33 A

Fig. 51 A

Fig. 67

Fig. 79



مولر پایین
F 820.220



ریشه کش پایین
F 820.331



ریشه کش بالا
F 820.510



عقل بالا
F 820.670



عقل پایین
F 820.790

Fig. 86 A

Fig. 86 C

Fig. 89

Fig. 90



کاهورن پایین
F 820.861



کاهورن پایین محدب
F 820.863



کاهورن بالا راست
F 820.890



کاهورن بالا چپ
F 820.900

Extraction Routurier Forceps



مولر
پایین چپ
K 1161
Fig. 86 L



مولر
پایین راست
K 1162
Fig. 86 R



کاهورن
پایین چپ
K 1163
Fig. 86 L



کاهورن
پایین راست
K 1164
Fig. 86 R

Extraction Forceps European Pattern

فورسپس های بزرگسال (۱۱ عددی)



F 750.001

K 1100

1 each of : Fig. 2 , 7 , 13

17 , 18 , 22 , 33A , 51A

67 , 79 , 86A



Fig. 2

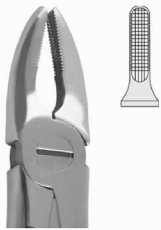

سانترال بالا
F 750.020
K 1102

Fig. 7



پرمولر بالا
F 750.070
K 1103

Fig. 17



مولر بالا راست
F 750.170
K 1104

Fig. 18



مولر بالا چپ
F 750.180
K 1105

Fig. 51 A

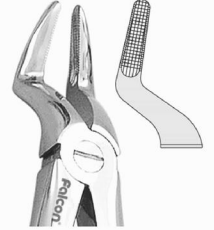

ریشه کش بالا
F 750.511
K 1106

Fig. 67

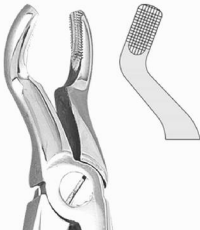

عقل بالا
F 750.670
K 1107

Fig. 13



پر مولر پایین
F 750.130
K 1108

Fig. 22



مولر پایین
F 750.220
K 1109

Fig. 33 A



ریشه کش پایین
F 750.331
K 1110

Fig. 79



عقل پایین
F 750.790
K 1111

Fig. 86 A



کاهورن پایین
F 750.861
K 1112

Fig. 89



کاهورن بالا راست
F 750.890
K 1114

Fig. 90



کاهورن بالا چپ
F 750.900
K 1115

Fig. 51 M

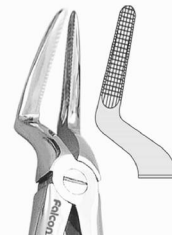

ریشه کش بالا نوک بلند
F 750.515
K 1119

Fig. 33 M



ریشه کش پایین نوک بلند
F 750.335
K 1120

Fig. 29 N



ریشه کش سانترال بالا
F 750.295
K 1121

Fig. 30 L



ریشه کش بالا باریک
K 1122

Fig. 151 1/2



ریشه کش بالا نوک ویژه
F 751.510

Fig. 86 C



کاهورن پایین محدب
F 750.863
K 1125

Fig. 87



کاهورن عقل
F 750.870

Extraction Forceps Children Pattern

فورسیس های اطفال فنردار



ست فورسیس اطفال
فنردار ۷ عددی
F 650.000
K 1200



Fig. 137



سانترال بالا
F 651.370
K 1175

Fig. 139



پرمولر بالا
F 651.390
K 1176

Fig. 3



مولر بالا چپ و راست
F 650.030
K 1177

Fig. 51 S



ریشه کش بالا
F 650.517
K 1178

Fig. 7



ریشه کش پایین
F 650.070
K 1179

Fig. 6



مولر پایین
F 650.060
K 1180

Fig. 5



پر مولر پایین
F 650.050
K 1181

Extraction Forceps Children Pattern

فورسیس های اطفال بدون فنر



ست فورسیس اطفال
بدون فنر ۱۰ عددی
F 500.001



Fig. 37



سانترال بالا
F 500.370
Upper Incisors

Fig. 38



سانترال پایین
F 500.380
Lower Incisors and Canines

Fig. 30 S



ریشه کش بالا صاف
F 500.307
Upper Roots

Fig. 39



پرمولر بالا
F 500.390
Upper Molars

Fig. 39 L



مولر بالا چپ
F 500.395
Upper Molars Left

Fig. 39 R



مولر بالا راست
F 500.397
Upper Molars Right

Fig. 51 S



ریشه کش بالا
F 500.517
Upper Roots

Fig. 33 S



ریشه کش پایین
F 500.337
Lower Roots

Fig. 13 S



پرمولر پایین
F 500.137
Lower Premolars

Fig. 22 S



مولر پایین
F 500.227
Lower Molars

Bone Thickness Gauges

گیج های استخوان کاستویجو

K 2785
Castroviejo
Straight
9 cm
0-20 mm



K 2786
Castroviejo
Curved
9 cm
0-20 mm



K 2787
Castroviejo
Straight
9 cm
0-40 mm



K 2788
Castroviejo
Curved
9 cm
0-40 mm



K 2789
Castroviejo
Straight
15 cm
0-40 mm



K 2790
Castroviejo
Curved
15 cm
0-40 mm



K 2791
Castroviejo
15 cm
0-40 mm



K 2792
Castroviejo
Straight
17 cm
0-40 mm



K 2793
Castroviejo
Curved
17 cm
0-40 mm



K 2794
Castroviejo
17 cm
0-40 mm

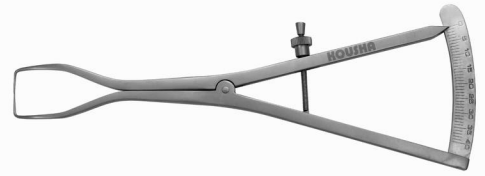

F 803.010
K 2795
Ridge Mapping
0-25 Range



F 804.010
Fig. 1
Castroviejo
Straight



F 804.020
Fig. 2
Castroviejo
Curved



F 804.030
Fig. 3
Castroviejo



F 804.040
Fig. 4
Castroviejo



F 804.050
Fig. 5
Castroviejo



Bone Mill

بن میل (آسیاب استخوان)

- Designed by Giuliano Lorenzetti, President of Falcon Medical Italia Srl.
- Simple and practical design
- Supplied with three interchangeable Titanium crushing heads of which two (fine and coarse serrations) for manual grinding and one for hammer percussion.
- Titanium bone container
- Registered Design



F 850.000 With TiN golden coating
F 850.001 Without TiN coating

Titanium

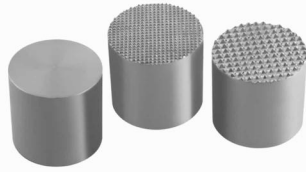

Bone Well

گوده استخوان



F 853.010



K 3465

Bone Mill / Morselizer

فورسپس بن میل



F 851.010
K 3451



F 849.010
Stainless steel bone scraper straight, complete with one blade



بن اسکرپر سر کج

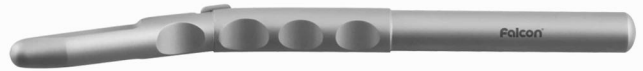

F 849.020
Stainless steel universal blade for straight or curved bone scraper



تیغه یدک بن اسکرپر

F 849.030
Stainless steel universal blade for straight or curved bone scraper

Bone Collectors

جمع کننده استخوان همراه با فیلتر



بن کالکتر کوچک F 854.001 Ø 7 mm

F 854.011 Ø 7 mm
Disposable stainless steel cartridge
Pack of 10 pieces



بن کالکتر بزرگ F 854.000 Ø 12 mm

F 854.010 Ø 12 mm
Disposable stainless steel cartridge
Pack of 10 pieces

Bone Injectors

بن کریر



ساده

F 855.011 Fig. 1

F 855.021 Fig. 2

F 855.031 Fig. 3

F 855.041 Fig. 4

F 855.010 Fig. 1

F 855.020 Fig. 2

F 855.030 Fig. 3

F 855.040 Fig. 4



تیتانیومی

Periotomes

پریوتوم

F => FALCON
K => KOUSHA

Falcon
Your Instruments since 1975



Anterior | F 846.015 | Fig. 1



Posterior | F 846.025 | Fig. 2



Anterior | F 846.035 | Fig. 3

Tin Coated Periotomes

پریوتوم روکش تیتانیوم



Posterior | K 3455 | Fig. 1



Anterior | K 3456 | Fig. 2



Anterior Straight | K 3457 | Fig. 1



Anterior Straight Curved | K 3458 | Fig. 2



Anterior Angle Curved | K 3459 | Fig. 3



Anterior Curved | K 3460 | Fig. 4

Titanium Periosteal Elevators

الواتور پریوست های تیتانیومی



Buser | F 832.015 T | Fig. 1



Prichard | F 839.035 T | Fig. 3



Molt Hollow | K 1715 T | Fig. 1



Buser | K 1720 T | Fig. 2

Periosteal Elevators and Raspatories

الواتور های پریوست



Molt | F 660.097
Small | K 1709



Molt | F 660.098
Medium | K 1710



Prichard | F 665.037
K 1862



OHL | F 663.100 | Fig. 10



Allen | F 830.091 | Fig. 9 A



Buser | F 832.015 | Fig. 1



Buser | F 832.025 | Fig. 2



Buser | F 832.035 | Fig. 3



Raspatory For Fine Tissue | F 845.015 | Fig. 1



Raspatory For Fine Tissue | F 845.025 | Fig. 2



Atraumatic Papilla elevator | F 838.015 | Fig. 1



F 828.250 | Fig. 25

Applicators and Compactors

قلم های حمل مواد و کامپکتور

F => FALCON
K => KOUSHA

Falcon
Your Instruments since 1975



Applicator bone | F 863.015 | Fig. 1



Applicator and compactor | F 864.015 | Fig. 1



Bone compactor | F 865.015 | Fig. 1



Bone compactor | F 865.025 | Fig. 2

Membrane Placement Instruments



قلم ممبران | F 867.015



پنس ممبران | F 868.010

Open Sinus Lift Set

ست سینوس لیفت اپن

K 3380



Open Sinus Lift Set

ست سینوس لیفت اپن

F 874.005 t

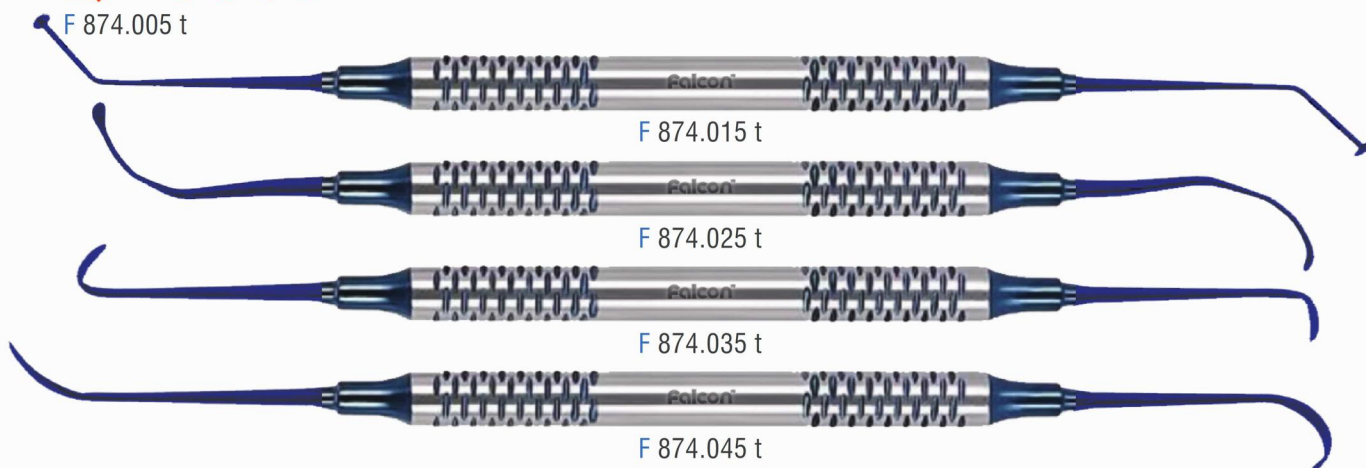

F 874.015 t

F 874.025 t

F 874.035 t

F 874.045 t



Sinus Lift Curettes

Sinus Lift Elevators



F 872.015
Fig. 1



F 873.015
Fig. 1

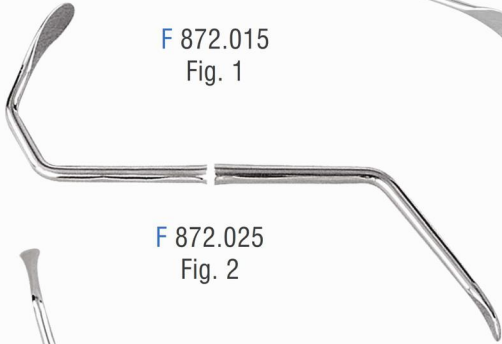

F 872.025
Fig. 2



F 873.025
Fig. 2

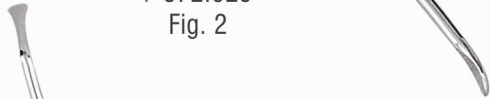

F 872.035
Fig. 3



F 873.035
Fig. 3



F 872.045
Fig. 4



F 873.045
Fig. 4



F 872.055
Fig. 5



F 873.055
Fig. 5



F 872.065
Fig. 6



F 873.065
Fig. 6



F 872.075
Fig. 7



F 873.075
Fig. 7

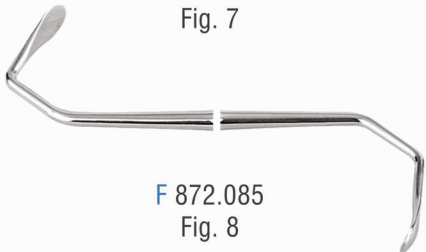

F 872.085
Fig. 8



F 873.085
Fig. 8









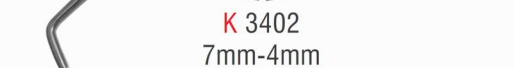

Open Sinus Lift

سينوس ليفت

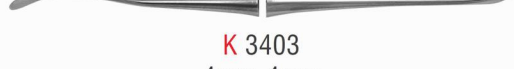

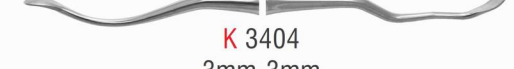

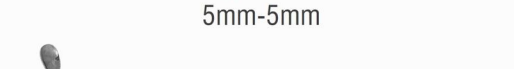





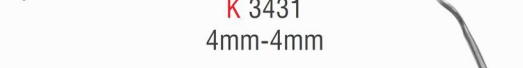

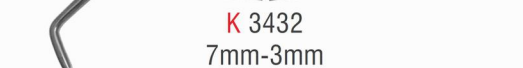
K => KOUSHA



Dulled

- 
K 3401
4mm-4mm
- 
K 3402
7mm-4mm
- 
K 3403
4mm-4mm
- 
K 3404
3mm-3mm
- 
K 3405
5mm-5mm
- 
K 3406
4mm-3mm
- 
K 3407
7mm-7mm
- 
K 3408
7mm-4mm
- 
K 3409
5mm-5mm
- 
K 3410
3mm-5mm
- 
K 3411
3mm-5mm
- 
K 3412
5mm-5mm
- 
K 3413
5mm-5mm

Cutting

- 
K 3431
4mm-4mm
- 
K 3432
7mm-3mm
- 
K 3433
4mm-4mm
- 
K 3434
3mm-3mm
- 
K 3435
5mm-5mm
- 
K 3436
4mm-3mm
- 
K 3437
7mm-7mm
- 
K 3438
7mm-4mm
- 
K 3439
5mm-5mm
- 
K 3440
3mm-5mm
- 
K 3441
3mm-5mm
- 
K 3442
5mm-5mm
- 
K 3443
5mm-5mm

Osteotomes with Stop Concave

استوتوم



Red F 901.122 2.2 mm	Green F 901.128 2.8 mm	Blue F 901.135 3.5 mm	Purple F 901.142 4.2 mm	Black F 901.148 4.8 mm	Red F 911.122 2.2 mm	Green F 911.128 2.8 mm	Blue F 911.135 3.5 mm	Purple F 911.142 4.2 mm	Black F 911.148 4.8 mm
----------------------------	------------------------------	-----------------------------	-------------------------------	------------------------------	----------------------------	------------------------------	-----------------------------	-------------------------------	------------------------------

Osteotomes with Stop Convex

بن اکسپندر



Red F 931.122 1.5-2.2 mm	Green F 931.128 2.2-2.8 mm	Blue F 931.135 2.8-3.5 mm	Purple F 931.142 3.5-4.2 mm	Black F 931.148 4.2-4.8 mm	Red F 936.122 1.5-2.2 mm	Green F 936.128 2.2-2.8 mm	Blue F 936.135 2.8-3.5 mm	Purple F 936.142 3.5-4.2 mm	Black F 936.148 4.2-4.8 mm
--------------------------------	----------------------------------	---------------------------------	-----------------------------------	----------------------------------	--------------------------------	----------------------------------	---------------------------------	-----------------------------------	----------------------------------

Osteotomes with Stop Concave

استوتوم



Blue K 3310 2.2 mm	Green K 3311 2.7 mm	Red K 3312 3.2 mm	Purple K 3313 3.7 mm	Black K 3314 4.2 mm	Yellow K 3315 4.7 mm	Blue K 3316 2.2 mm	Green K 3317 2.7 mm	Red K 3318 3.2 mm	Purple K 3319 3.7 mm	Black K 3320 4.2 mm	Yellow K 3321 4.7 mm
--------------------------	---------------------------	-------------------------	----------------------------	---------------------------	----------------------------	--------------------------	---------------------------	-------------------------	----------------------------	---------------------------	----------------------------

Osteotomes with Stop Convex

بن اکسپندر



Blue K 3360 2.2-2.7mm	Green K 3361 2.7-3.2mm	Red K 3362 3.2-3.7mm	Purple K 3363 3.7-4.2mm	Black K 3364 4.2-4.7mm	Blue K 3365 2.2-2.7mm	Green K 3366 2.7-3.2mm	Red K 3367 3.2-3.7mm	Purple K 3368 3.7-4.2mm	Black K 3369 4.2-4.7mm
-----------------------------	------------------------------	----------------------------	-------------------------------	------------------------------	-----------------------------	------------------------------	----------------------------	-------------------------------	------------------------------



13K/TG | K 1754 T | Tin Coated | Inner



13K/TG | K 1755 T | Tin Coated | Outer



13K/TG | K 1754 | Fig 2 | Inner



13K/TG | F 028.135 | K 1755 | Fig 1 | Outer



13K/13KL | F 040.365 | K 1756



Back Action | K 1757



Chisel Hatchet | F 340.525 | Fig 51/52



Straight Chisel | K 1753 | Fig 2



Gardner | F 055.010 | 3 mm



Gardner | F 055.020 | 4 mm



Wakefield | F 070.010 | 2.7 mm



Wakefield | F 070.020 | 3 mm



Ochenbein | F 078.010 | Fig. 1

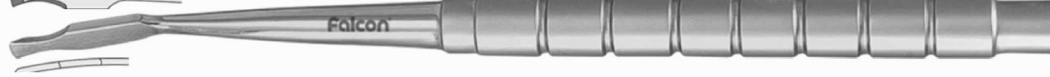

Ochenbein | F 078.020 | Fig. 2

Periodontal Files

بن فایل بین دندانی

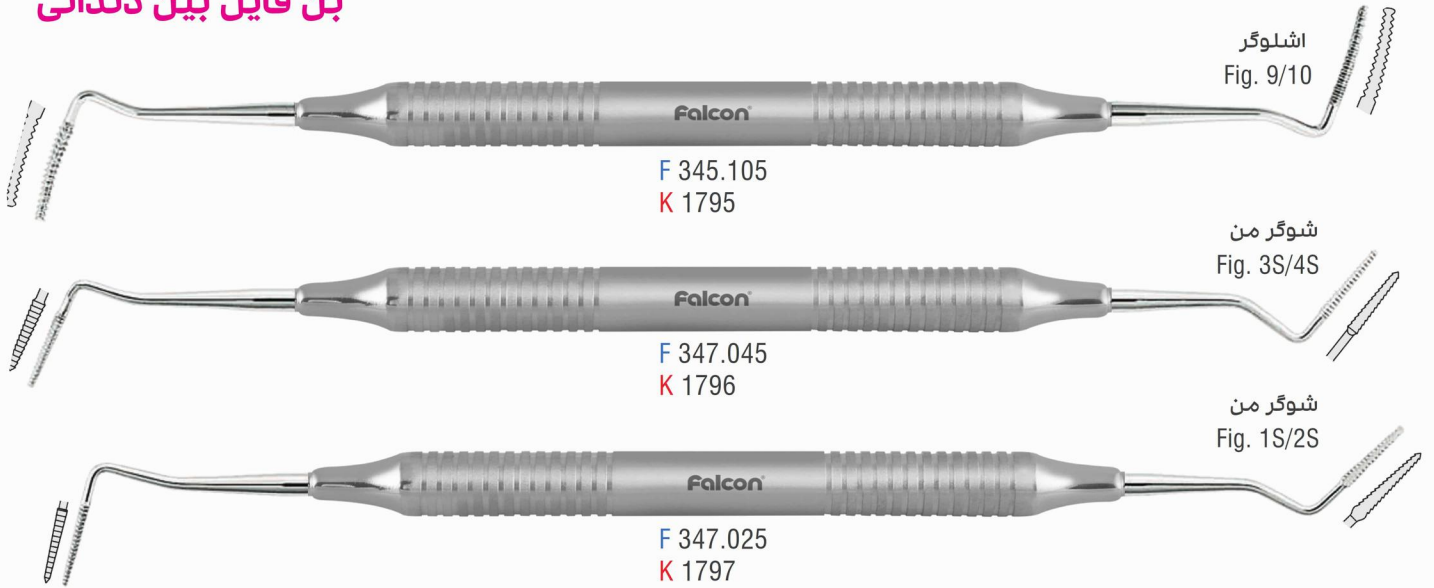

Bone Files

بن فایل میلر

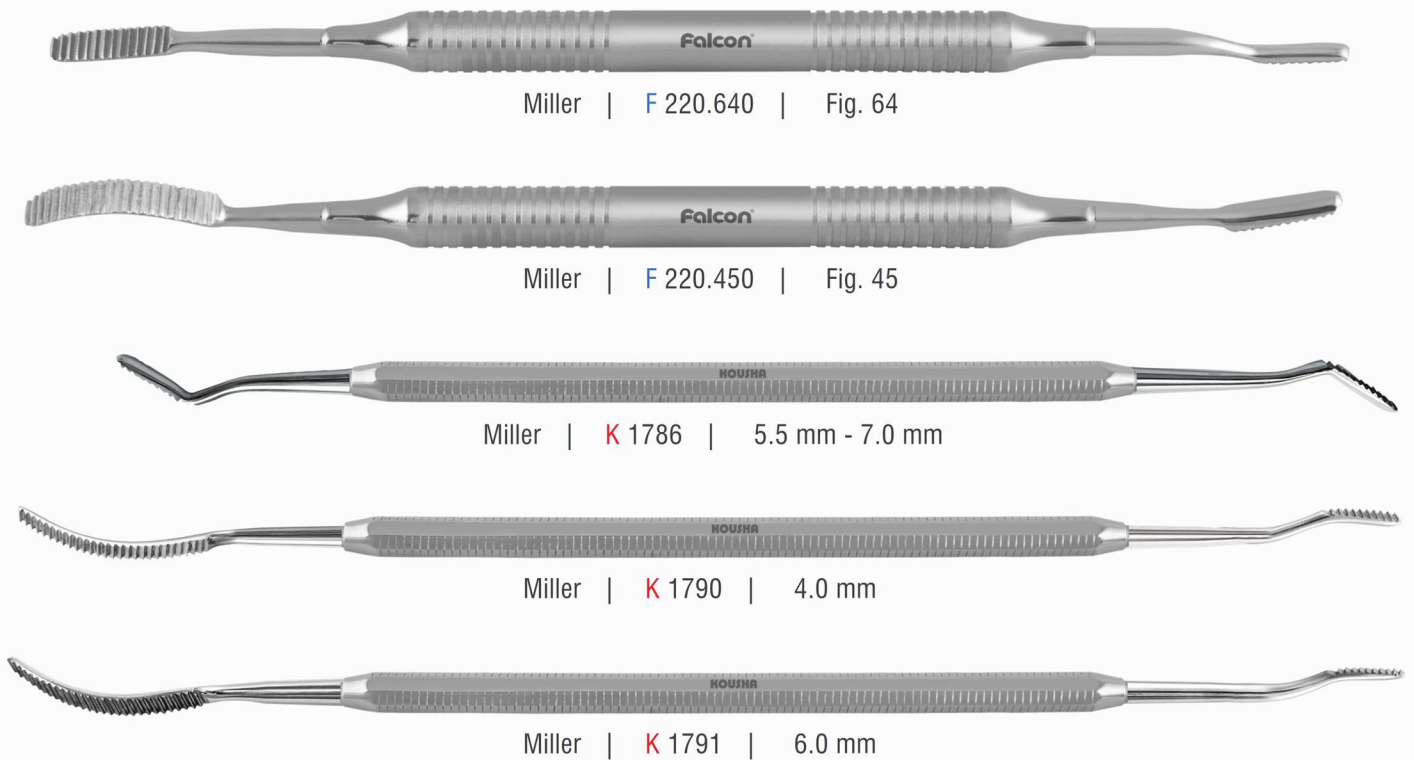

Knife Gingivectomy

چاقوهای جراحی



Bone Curettes Hemingway

کورت قاشقی

دسته ساده



Hemingway | F 100.017 | K 1737 | Fig. 1

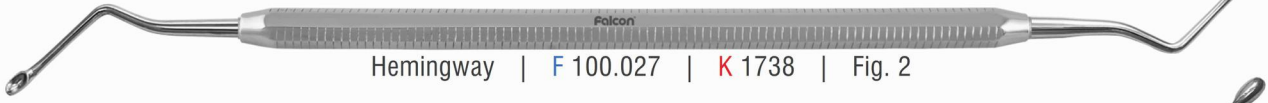

Hemingway | F 100.027 | K 1738 | Fig. 2



Hemingway | F 100.037 | K 1739 | Fig. 3



Hemingway | F 100.047 | K 1740 | Fig. 4

دسته هالو



Hemingway Hallow Handle | F 100.015 | Fig. 1



Hemingway Hallow Handle | F 100.025 | Fig. 2



Hemingway Hallow Handle | F 100.035 | Fig. 3



Hemingway Hallow Handle | F 100.045 | Fig. 4

Bone Curettes Lucas

کورت لوکاس

دسته ساده

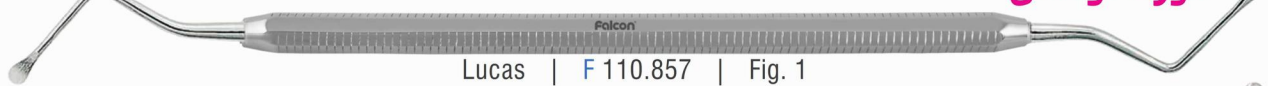

Lucas | F 110.857 | Fig. 1

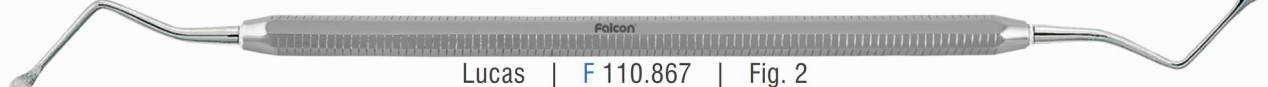

Lucas | F 110.867 | Fig. 2

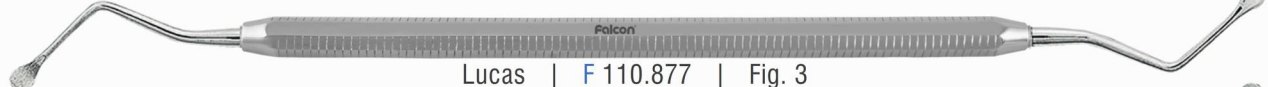

Lucas | F 110.877 | Fig. 3

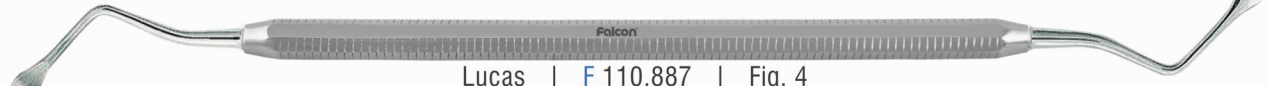

Lucas | F 110.887 | Fig. 4

دسته هالو



Lucas Hallow Handle | F 110.855 | Fig. 1



Lucas Hallow Handle | F 110.865 | Fig. 2



Lucas Hallow Handle | F 110.875 | Fig. 3



Lucas Hallow Handle | F 110.885 | Fig. 4

Endodontic Retractors

رتريكتور هاي اندودنتيك



10 mm | Fig. 1
F 488.014



10 mm | Fig. 2
F 488.024



15 mm | Fig. 3
F 488.034

Molt Retractor

دهان باز كن مولت



Small | 100 mm
F 065.100 | K 2979



Medium | 110 mm
F 065.110 | K 2980



Large | 140 mm
F 065.140 | K 2981

Mallets

چکش



F 273.190 | K 2211



Partsch
F 270.190

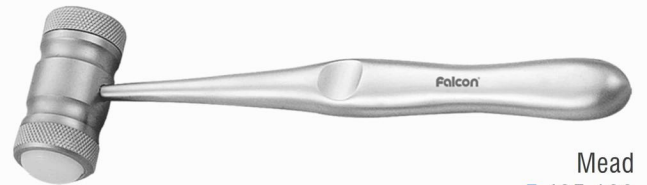

Mead
F 435.190

Rongeurs

رانژور

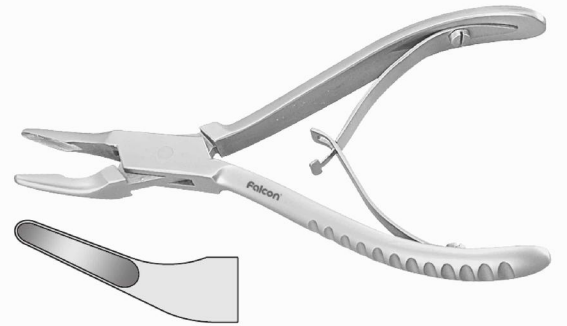

Friedman-Mini | 125 mm
F 740.125 | K 2225

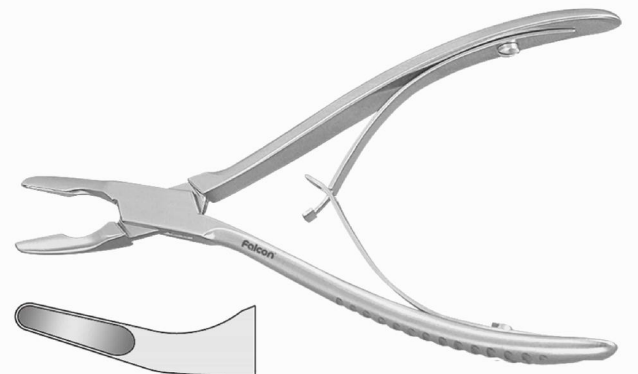

Friedman | 140 mm
F 741.140 | K 2226

Retractors رترکتور



مینہ سوتا
F 416.010
K 2901



نپ گیر
F 310.200
200 mm



رترکتور یک سر
F 435.010
105 mm



رترکتور دو سر
F 435.020
105 mm



فارابوف بزرگ
F 250.150
K 2906



فارابوف كوچك
F 250.120
K 2905



راكس
F 330.150
150 mm



زبان گیر
F 298.010
140 mm



کلمبیا
F 389.145
145 mm



استرانبرگ | F 430.010 | 120 mm
استرانبرگ | F 430.020 | 140 mm
استرانبرگ | F 430.030 | 150 mm



رترکتور لب و گونه
F 848.050
200 mm

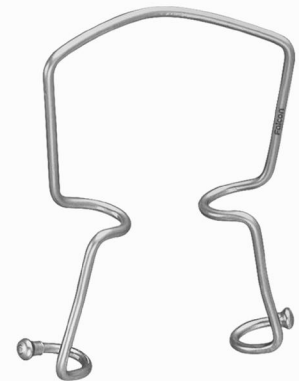

اورینگ
F 427.031
Set of 3 pieces

Castroviejo Needle Holders

سوزنگیر های کاستویجو
با روکش تنگستن کارباید



Castroviejo Needle Holders

سوزنگیر های کاستویجو



Micro Scissors

قیچی های میکرو

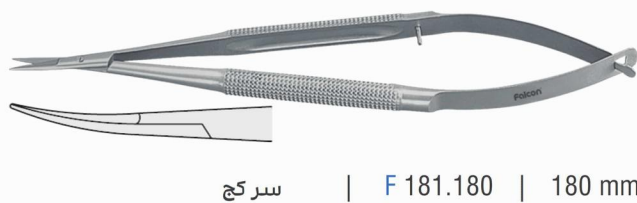
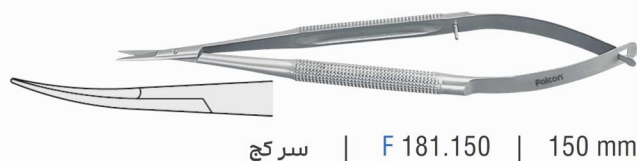

Castroviejo Scissors

قیچی های کاستویجو

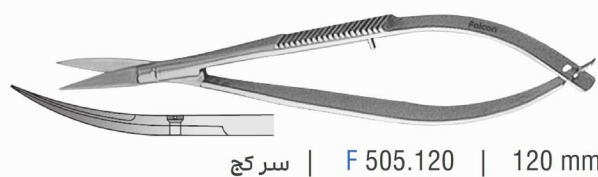
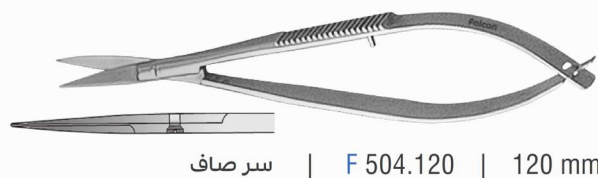

Iris Scissors

ایریس سر صاف
F 540.115
K 2021
115 mm

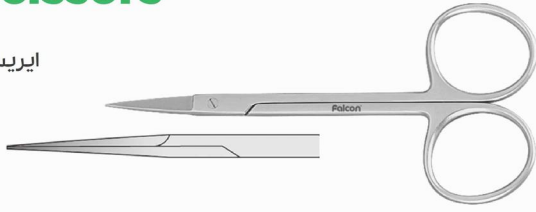

ایریس سر کج
F 541.115
K 2022
115 mm

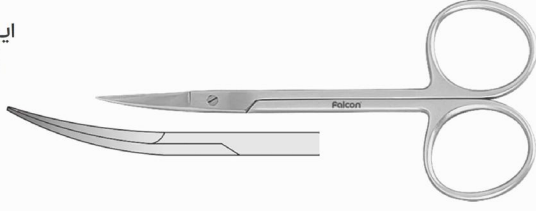

ایریس
دسته خم دار
(La grange)
F 549.115
K 2025
115 mm



Goldman Fox Scissors

جراحی سر صاف
F 536.010
K 2010
130 mm

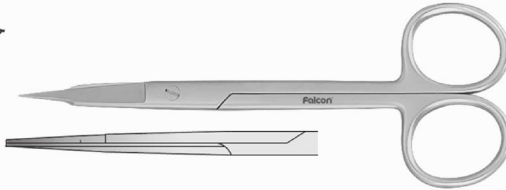

جراحی سر کج
F 537.010
K 2011
130 mm

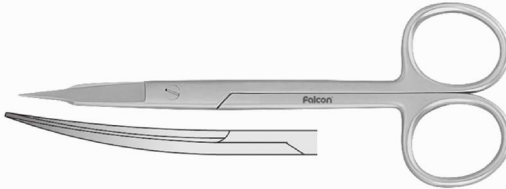

جراحی دسته خم دار
F 539.010
130 mm

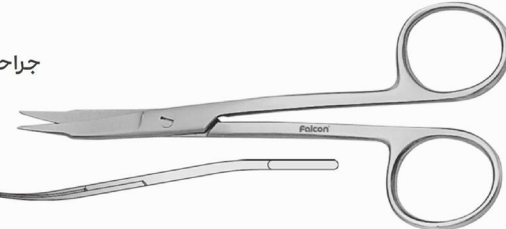

Metzenbaum Scissors

متز سر صاف
F 762.145 | 145 mm



متز سر کج
F 763.145 | 145 mm



Iris with Tungsten Carbide

ایریس سر صاف با روکش TC
F 100.115 | 115 mm

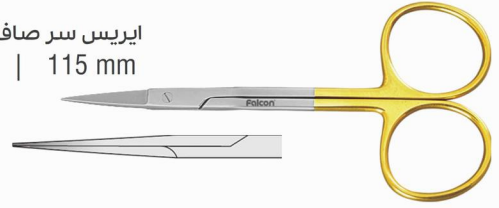

ایریس سر کج با روکش TC
F 101.115 | 115 mm



Goldman Fox with Tungsten Carbide

جراحی سر صاف با روکش TC
F 600.130 | 130 mm

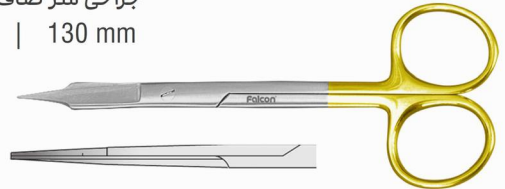

جراحی سر کج با روکش TC
F 601.130 | 130 mm

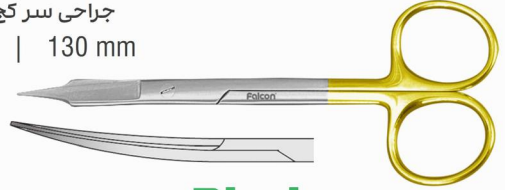

Scissors, one Blade Serrated

دنداندار سر صاف
F 536.011 | 130 mm

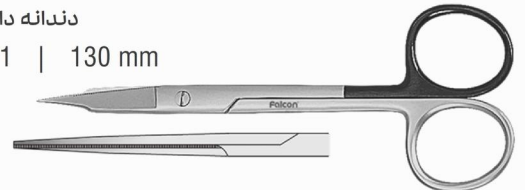

دنداندار سر کج
F 537.011 | 130 mm



Crown Scissors

قیچی کراون بر سر صاف SSC
F 920.120 | 120 mm

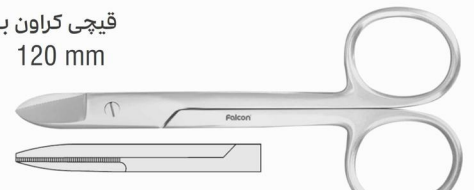

قیچی کرون بر سر کج SSC
F 921.120 | 120 mm

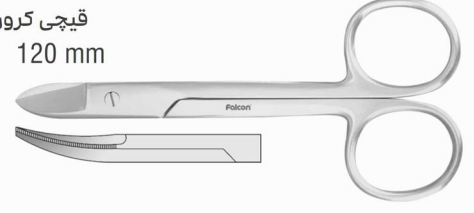

Scalpel Handles

دسته تیغ



F 550.030
K 2204
دسته بیستوری شماره ۳

For scalpel blades no: 10, 11, 12, 12D, 13, 15, 15C



F 552.030
Fig. 3 G
دسته بیستوری مدرج شماره ۳



F 650.040
Fig. 4
دسته بیستوری شماره ۴

For blades no : 20, 21, 22, 23, 24, 25

Stieglitz Forceps

سوزنگیر های نوک تیز



سر صاف
F 992.140
140 mm

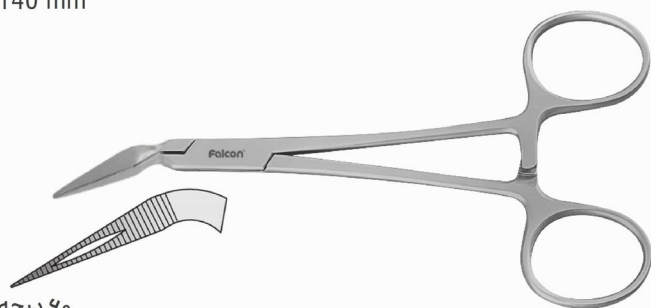

۴۰ درجه
F 993.135
135 mm



۹۰ درجه
F 994.125
125 mm

Suture Forceps



پنس بخیه
F 650.160
160 mm

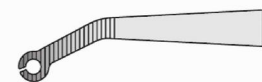

Dissecting and Tissue Forceps

پنس جراحی



F 370.120
K 1393
120 mm
پنس آدسون کوچک



K 1394
120 mm
پنس آدسون کوخری



F 370.150
150 mm
پنس آدسون بزرگ



F 500.145
K 1380
145 mm
پنس مستقیم متوسط



F 502.145
K 1375
145 mm
پنس مستقیم باریک



F 750.145
K 1390
145 mm
پنس مستقیم کوخری متوسط



F 750.130
K 1389
145 mm
پنس مستقیم کوخری باریک

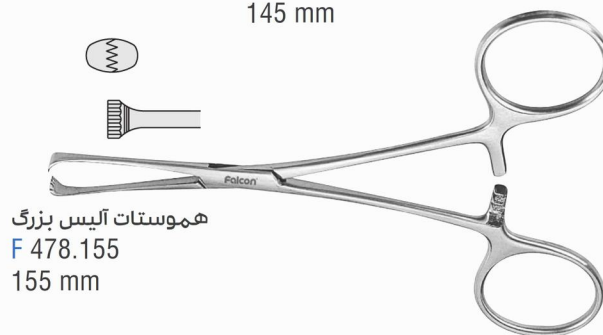

هموستات آلیس بزرگ
F 478.155
155 mm

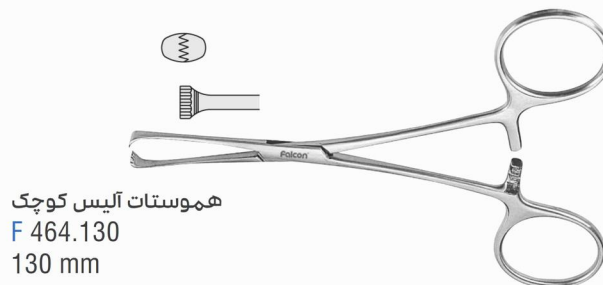

هموستات آلیس کوچک
F 464.130
130 mm

Needle Holders

سوزنگیر کوچک
F 598.130 | 130 mm

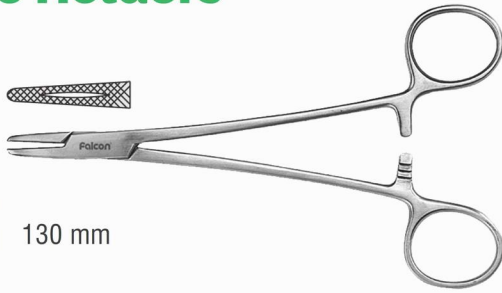

سوزنگیر نازک
F 596.140
K 3163
140 mm

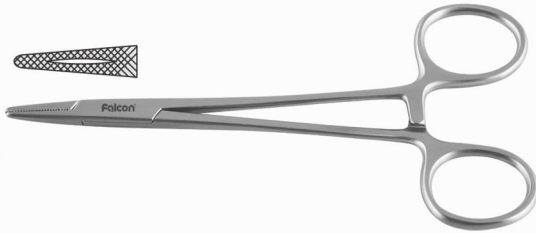

سوزنگیر سرکج
F 597.140
K 3164
140 mm

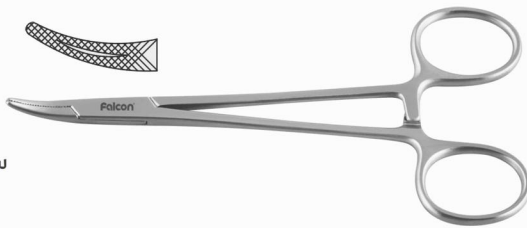

0.5 mm
سوزنگیر کوچک با روکش TC
F 298.130
130 mm



0.5 mm
سوزنگیر متوسط با روکش TC
F 298.140
140 mm



Needle Holders Mathieu TC

0.4 mm
سوزنگیر متیو با روکش TC
F 412.140
140 mm



Hemostatic Forceps

فورسپس موسکیتو سر صاف
F 224.125
K 3109
125 mm

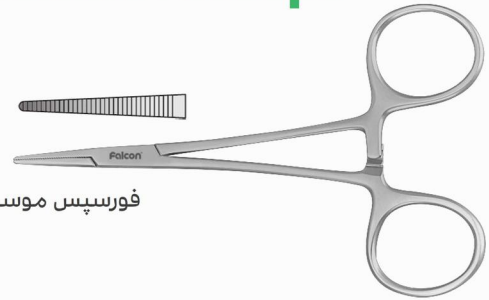

فورسپس موسکیتو سر کج
F 225.125
K 3110
125 mm

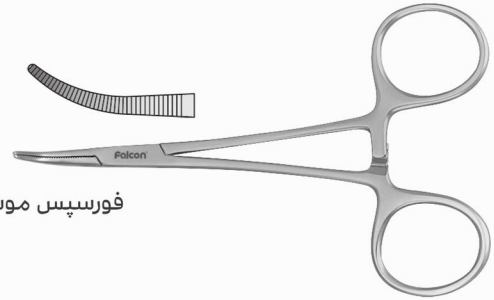

هموستات سر صاف
F 270.145
K 3010
145 mm

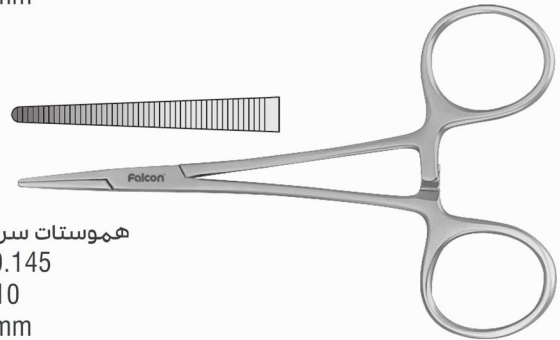

هموستات سر کج
F 271.145
K 3011
145 mm

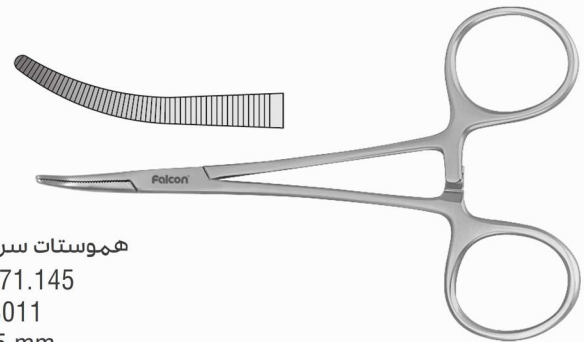

Needle Holders Mathieu سوزنگیر متیو

نوک استاندارد
F 392.020
140 mm



نوک ظریف
F 392.030
140 mm



Suction Tubes

سر ساکشن های فلزی طرح فالکن



F 631.015
Fig. 5
1.5 mm



F 631.040
Fig. 12
4.0 mm



1.5 mm

F 631.030
Fig. 9
3.0 mm



4.0 mm

F 631.050
Fig. 15
5.0 mm

3.0 mm

5.0 mm

Towel Forceps

شانگیر



Backhaus - 90 mm
F 431.090

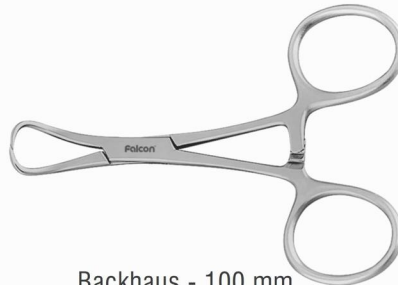

Backhaus - 100 mm
F 431.110

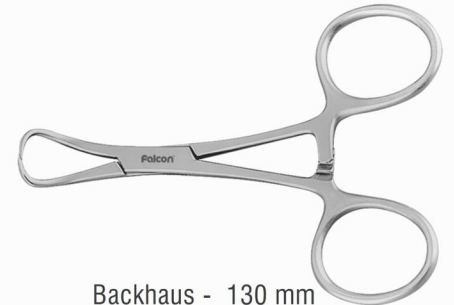

Backhaus - 130 mm
F 431.130

Frazier Suction Tubes

سر ساکشن های فلزی



K 2285
Fig. 8

2.7 mm



K 2288
Fig. 11

3.7 mm



K 2286
Fig. 9

3.0 mm



F 201.120 | K 2289
Fig. 12

4.0 mm



F 201.100 | K 2287
Fig. 10

3.3 mm



K 2292
Fig. 15

5.0 mm

Ladmore tongue deflector

سر ساکشن همراه با زبانگیر



Ladmore - Fig. 1
F 635.010



Ladmore - Fig. 2
F 635.020

Bite Gauge

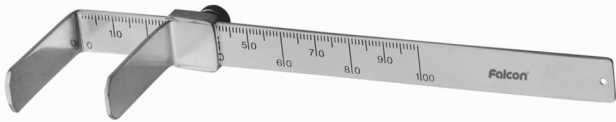

گیج بایت | F 001.000

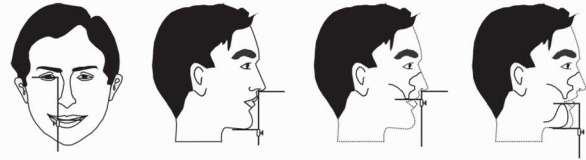

Boley Gauges



گیج اندازه گیری با قفل اهرمی | F 100.010

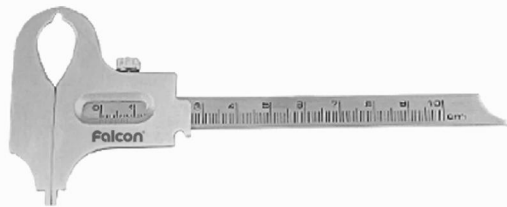

گیج اندازه گیری با قفل پیچی | F 100.020

Calipers Iwanson



گیج فلز | F 101.010



گیج موم | F 101.020

Plaster Cutter



قیچی گج بر سر صاف | F 325.200



قیچی گج بر سر کج | F 326.200

Wax Modeling Carvers

اسپاتول لکرون مینی



Lecron-mini | F 882.020 | Fig. 2 | 130 mm

اسپاتول لکرون



Lecron | F 880.020 | K 2728 | Fig. 2 | 165 mm

وکس کارور هایلین



Hylin | F 875.010 | K 2727 | Fig. 1 | 135 mm

اسپاتول وکساب زاهله



Zahle | F 945.060 | K 2726 | Fig. 6 | 115 mm

Ceramic Sculpturing Instruments

اسپاتول پودرگذاری

(باسر قابل تعویض)



F 955.010



F 955.020



F 955.030



ست سه عددی | F 955.000

P.K. Thomas Instruments

قلم های پی کی توماس

دسته ساده

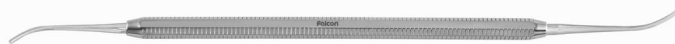

F 900.017 | Fig. 1



F 900.027 | Fig. 2

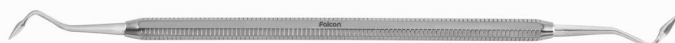

F 900.037 | Fig. 3



F 900.047 | Fig. 4



F 900.057 | Fig. 5

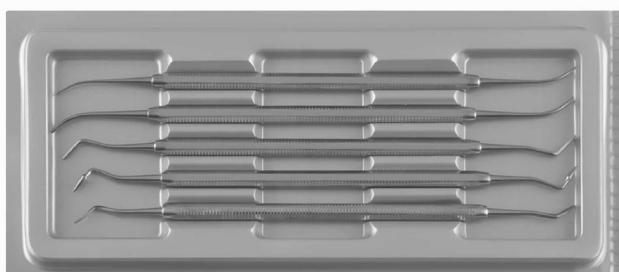

ست پی کی توماس دسته هشت گوش ۵ عددی

F 900.007 | Set of 5

Aluminum Handle

دسته آلومینیومی

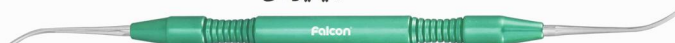

F 905.010 | Fig. 1



F 905.020 | Fig. 2



F 905.030 | Fig. 3



F 905.040 | Fig. 4



F 905.050 | Fig. 5

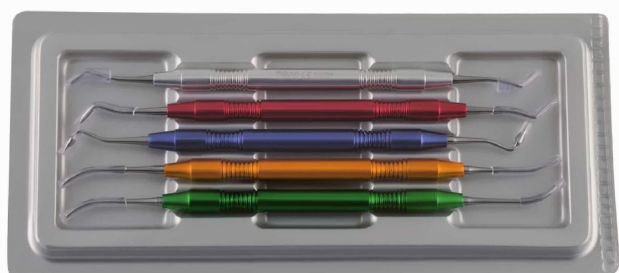

ست پی کی توماس دسته آلومینیومی ۵ عددی

F 905.000 | Set of 5

Plaster Spatulas

همزن های دسته چوبی



نازی Rigid | F 451.040 | Fig. 4 | 200 mm



پهن Rigid | F 451.050 | Fig. 5 | 215 mm



ساده Rigid | F 451.060 | K 2701 | Fig. 6 | 210 mm



سرکج Rigid | F 450.080 | K 2702 | Fig. 8 | 210 mm

Plaster Knives

چاقوهای گچ



F 330.010 | 180 mm



F 335.170 | 170 mm



F 335.160 | 160 mm

Wax Knives, Wooden Handle



چاقوی موم Fahrenstock | F 815.020 | K 2713 | 175 mm



چاقوی موم Fahrenstock | F 815.010 | K 2712 | 130 mm



اسپاتول موم Lessmann | F 825.020 | K 2711 | 175 mm



اسپاتول موم Lessmann | F 825.010 | K 2710 | 130 mm

Bone Expander

بن اکسپندر

K 3495



Band Pusher

بند پوشر



F 120.010 | Mershon

Band Seating Instrument

بند سیتر (قابل اتوکلاو)



F 125.010

Bracket Positioning Gauge

گیج های ارتفاع



F 205.018 | For .018" Slot brackets



F 205.022 | For .022" Slot brackets

Bracket Gauge

گیج براکت ستاره ای



F 200.010 | Boone

Bracket Placing Tweezers

پنس های براکت



F 210.135 | 135 mm



F 217.135 | 135 mm



F 220.110 | 110 mm

پنس های براکت تیغه دار



F 213.135 | 135 mm | Fig. 1



F 214.135 | 135 mm | Fig. 2



F 215.135 | 135 mm | Fig. 3

Buccal Tube Tweezers

پنس های باکال تیوب



F 227.120 | 120 mm



F 228.125 | 125 mm

Elastmeric Ligature Removing Tweezers

پنس برداشتن لیگاچرالاستیک



F 285.010 | 140 mm

Elastomeric Separators Placing Pliers



پلایر اسپراتور سر کج
F 271.165
165 mm Curved

Band Removing Pliers



پلایر بند ریمور
F 492.700

Bracket Removing Pliers Straight



پلایر برباکت ریمور سر صاف
F 511.700

Hard Wire Cutters



ساید کاتر
F 777.300

Plier Stands



جای پلایر
F 964.030

Mini Distal End Cutter With Safety Hold



دیسیتال اندکاتر
F 536.700

●	0.30 mm to 0.50 mm (.012" to .020")
■	Max. 0.46 mm x 0.64 mm (.018" x .025")
⊗	0.38 mm to 0.53 mm (.0155" to .0215")
⊠	Max. 0.53 mm x 0.64 mm (.021" x .025")

Hard Wire Cutter Straight



هارد وایر کاتر سر صاف مخصوص سیم های سخت
F 550.700

●	0.30 mm to 0.50 mm (.012" to .020")
■	Max. 0.56 mm x 0.71 mm (.022" x .028")

Soft Wire And Ligature Cutter Standard



لیگچر کاتر سر صاف مخصوص سیم های نرم
F 574.700

∩	.25 mm to .38 mm (.010" to .015")
---	-----------------------------------

Loop Forming Pliers



پلایر نانس
F 688.700 | Nance

●	0.36 mm to 0.71 mm (.014" to .028")
■	Max. 0.56 mm x 0.71 mm (.022" x .028")

3-Jaw Wire Bending Pliers



پلایر سه شاخ
F 585.700

●	0.30 mm to 0.50 mm (.012" to .020")
■	Max. 0.56 mm x 0.71 mm (.022" x .028")

Utility Pliers



پلاير وينگارد
Weingart
F 738.700

●	0.30 mm to 0.50 mm (.012" to .020")
■	Max. 0.56 mm x 0.71 mm (.022" x .028")



پلاير هاو سر صاف
How
F 664.700

●	0.30 mm to 0.50 mm (.012" to .020")
■	Max. 0.56 mm x 0.71 mm (.022" x .028")

Rectangular Arch Forming And Torquing Pliers (Ribbon Arch Pliers)



پلاير آرچ فورمينگ
F 616.300

Arch Forming And Contouring Pliers



پلاير دلا روزا
De la Rose
F 602.300

Bands Or Crowns Contouring Pliers For Contouring And Adapting



پلاير نوک مرغی
Gordon
F 460.300 N



پلاير جانسون
Gordon
F 465.300

Wire Bending Pliers



پلاير ۱۳۹
Angle round/Flat
F 812.300 N



پلاير يونيورسال
Adams
F 795.300 N

Surgical Ball Hook Crimping Pliers



پلاير کریمپیل هوک سر صاف
F 621.700

Sterilization Cassettes



سینی جراحی سیلیکون دار ۵ عددی
F 085.013
K 7000
Stainless steel for 5 instruments
182 x 72 x 34 mm



سینی جراحی سیلیکون دار ۱۰ عددی
F 085.023
K 7004
Stainless steel for 10 instruments
182 x 144 x 34 mm



سینی جراحی سیلیکون دار ۲۰ عددی
F 085.033
K 7005
Stainless steel for 20 instruments
288 x 182 x 34 mm

Instrument Trays Stainless Steel



سینی دریدار سوراخ دار
F 431.000
K 2558
Perforated, 288 x 187 x 40 mm

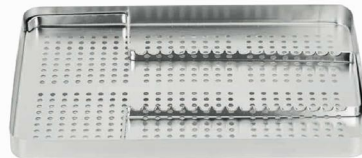

سینی بدون درب سوراخ دار
F 430.030 S
K 2550
Perforated, 288 x 187 x 40 mm



سینی بدون درب بدون سوراخ
F 430.040 S
K 2549
Solid, 288 x 187 x 40 mm

Instrument Trays Stainless Steel



سینی معاینه کوچک
F 420.020
K 2542
Small, 190 x 100 x 17 mm



سینی معاینه متوسط
F 420.021
K 2543
Medium, 190 x 135 x 17 mm



سینی معاینه بزرگ
F 420.022
K 2544
Large, 290 x 215 x 17 mm

Instrument Trays Stainless Steel



دیش دریدار کوچک
F 224.150
K 2554
Small, 230 x 150 x 50 mm



دیش دریدار متوسط
F 227.200
K 2555
Medium, 250 x 200 x 50 mm



دیش دریدار بزرگ
F 230.200
K 2556
Large, 300 x 200 x 50 mm

Forceps Jars Stainless Steel

چیتل



F 755.110 | 110mm.50mm
K 2523 | 110mm.50mm



F 755.130 | 130mm.50mm
K 2524 | 165mm.50mm



F 760.110 | 110mm.75mm
K 2525 | 130mm.75mm



F 760.130 | 130mm.75mm

Kidney Trays Stainless Steel

رسیور



F 570.150
K 2533
Small | 150 mm



F 570.180
K 2534
Medium | 180 mm



F 570.200
K 2535
Large | 200 mm

Drums Stainless Steel

بیگس گاز



K 2592
Extra Small | 90 x 90 mm



F 850.125
K 2593
Small | 125 x 125 mm



F 850.140
K 2594
Medium | 140 x 140 mm



F 850.150
K 2595
Large | 150 x 150 mm

Gallipots Stainless Steel

گالی پات



F 600.010
K 2572
30 cc



F 600.020
K 2573
60 cc



F 600.030
K 2574
90 cc



F 600.040
K 2575
120 cc



F 600.060
K 2576
150 cc



F 600.080
K 2577
180 cc

Cotton Dispensers Stainless Steel

جای پنبه فنردار آلومینیومی



F 535.010



F 535.020



F 535.030



F 535.040



F 535.050

Cotton Container Stainless Steel

جای پنبه دربردار

4 x 4 inch
K 25663 x 3 inch
K 2565جای پنبه گلوله ای
F 532.000
K 2563جای پنبه فنردار
F 540.020
K 2561جای پنبه ستاره ای
F 544.010
K 2562**Alcohol Lamp**

چراغ الکی

چراغ الکی
ثابت
F 010.000چراغ الکی
قابل تنظیم بزرگ
F 015.020
K 2517چراغ الکی
قابل تنظیم کوچک
F 015.010
K 2516**Color Code Rings**حلقه علامت گذاری ابزار
(قابل اتوکلاو)F 080.000 Small, inner Ø 4 mm
F 081.000 Large, inner Ø 6 mm
Assorted colors, pack of 50 pieces**Endo Box**اندو باکس
مستطیلی

K 2583

X-Ray Clip

گیره فیلم

F 970.010
K 2502

راهنمای نگهداری و مصرف

به منظور استفاده بهینه از کالایی که خریداری شده لطفا موارد زیر را رعایت فرمایید:

روش شستشو وسایل:

کلیه ابزارها را با آب و صابون و برس با دستکش ضخیم تمیز بشوید، بطوریکه تمامی آج ها و دندانها از خون و یا هر گونه آلودگی پاک شوند. تمامی لوازم آلوده به خون را بلافاصله پس از استفاده با آب سرد بشویید زیرا خون پس از مدتی منعقد و شستن و پاک کردن آن مشکل می گردد و از طرفی ممکن است میکروارگانیسم موجود در خون در هنگام استریلیزاسیون زنده باقی بماند. در مرحله بعد ابزارها را در محلول ضد عفونی غوطه ور کرده و داخل دستگاه اولتراسونیک قرار دهید بعد از این مرحله برای بار دوم شستشوی دستی انجام گرفته، سپس کلیه وسایل را با دقت خشک کرده و پس از پاک کردن داخل دستگاه اتوکلاو قرار دهید. ابزار را بیش از اندازه در مواد ضد عفونی غوطه ور نسازید. حداکثر زمان پیشنهادی **۱۰ دقیقه** است. از انباشته شدن ابزارها روی هم خودداری کرده و ابزارهای سنگین تر را کف ظرف قرار دهید، برای جلوگیری از انتقال خوردگی و زنگ زدگی ابزارهای معیوب را جداسازی کرده و هرگونه قفل و بست ابزارها را رها سازید. تا حد امکان برای شستشو از آب مقطر استفاده کرده و از آب لوله کشی اجتناب کنید، آب معمولی و با سختی بالا می تواند باعث زنگ زدگی یا ایجاد لکه های کوچک بر روی ابزار گردد.

Falcon KOUSHA



WWW.KOUSHAFARIN.COM

 66572126

 66581497-9

📍 فروشگاه : خیابان آزادی روبروی دانشکده

دامپزشکی پاساژ کاوه راهروی دوم پلاک 16

📍 دفتر فروش : خیابان آزادی روبروی دانشکده

دامپزشکی پاساژ کاوه بلوک B طبقه اول واحد 66